

<b>Brandkrav:</b> K1 10 D-s2,d0 opsat på substrat A2-s1,d0 min. densitet 10kg/m3 (Se iverigt DoP). Opsættes med højest 25mm bagvedliggende hulrum		Titel: <b>SW01 AART 21x70mm, Salg</b>	
Tegner:	Dato <b>27-10-2020</b>	Godkendt af:	Godkendt dato:
Rev.	Rev. dato	Note: Alle mål er i mm. Tegningen er ikke målfast	Sheet <b>1/1</b>

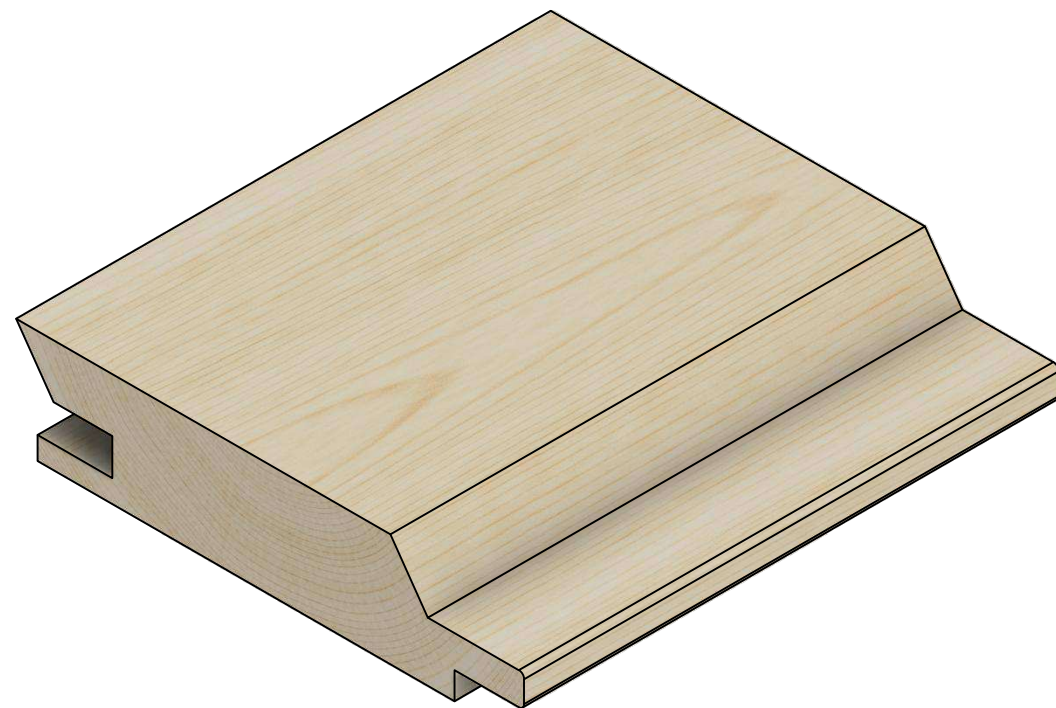

			
<b>Brandkrav:</b> K1 10 D-s2,d0 opsat på substrat A2-s1,d0 min. densitet 10kg/m3 (Se iverigt DoP). Opsættes med højest 25mm bagvedliggende hulrum		<b>Titel:</b> SW01 AART 21x95mm, Salg	
<b>Tegner:</b>	<b>Dato</b> 28-10-2020	<b>Godkendt af:</b>	<b>Godkendt dato:</b>
<b>Rev.</b>	<b>Rev. dato</b>	<b>Note:</b> Alle mål er i mm. Tegningen er ikke målfast	<b>Sheet</b> 1/1

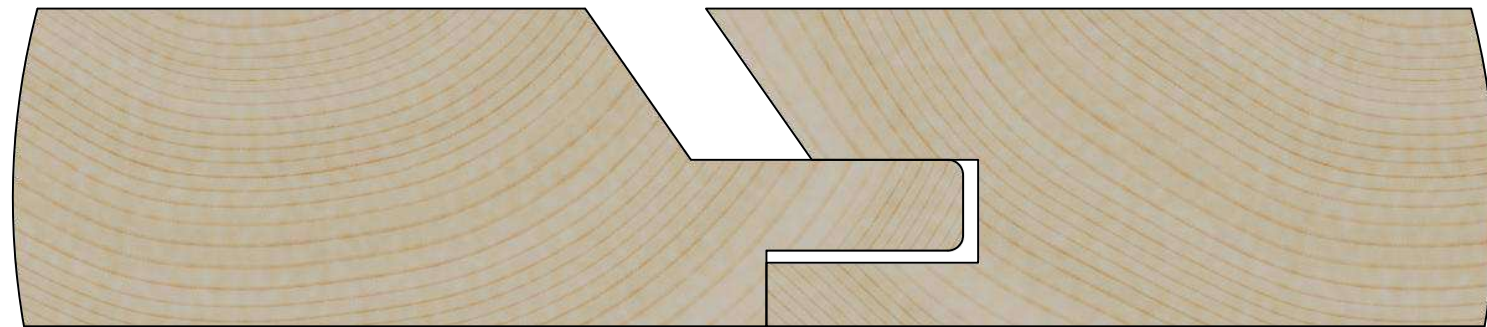
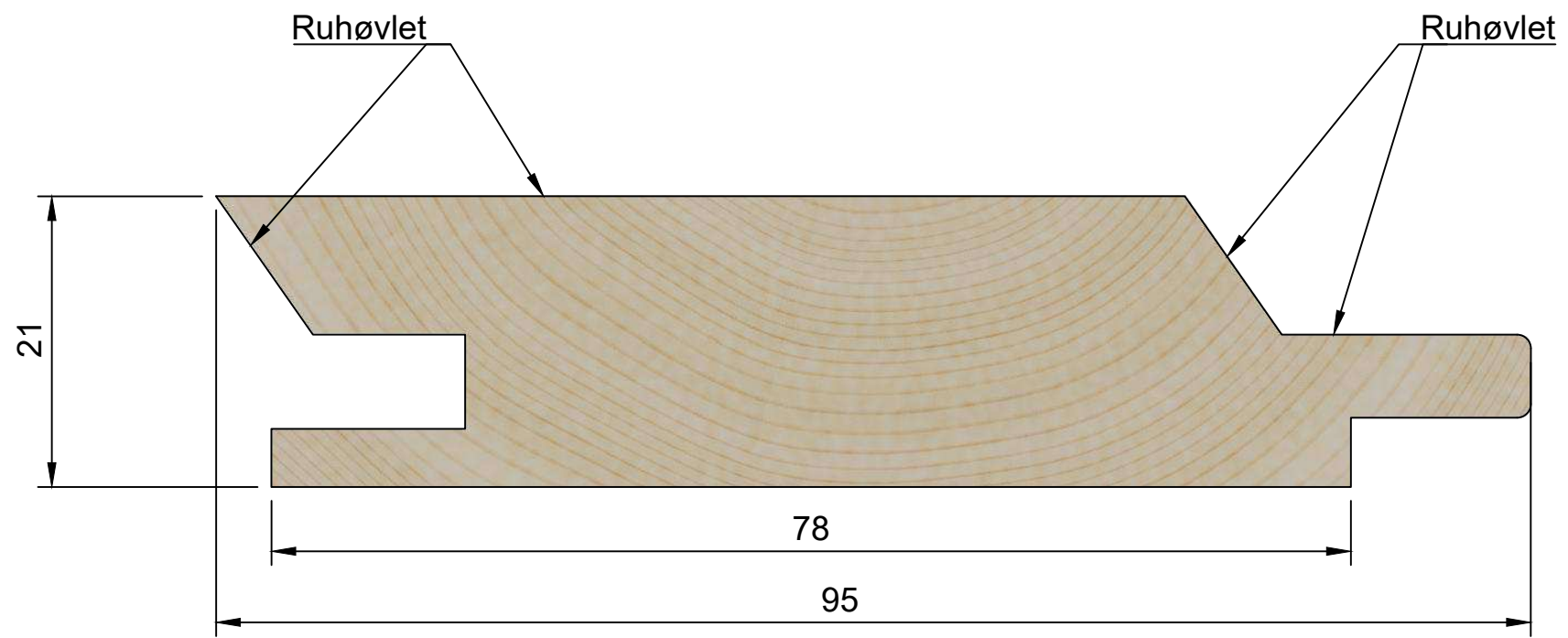
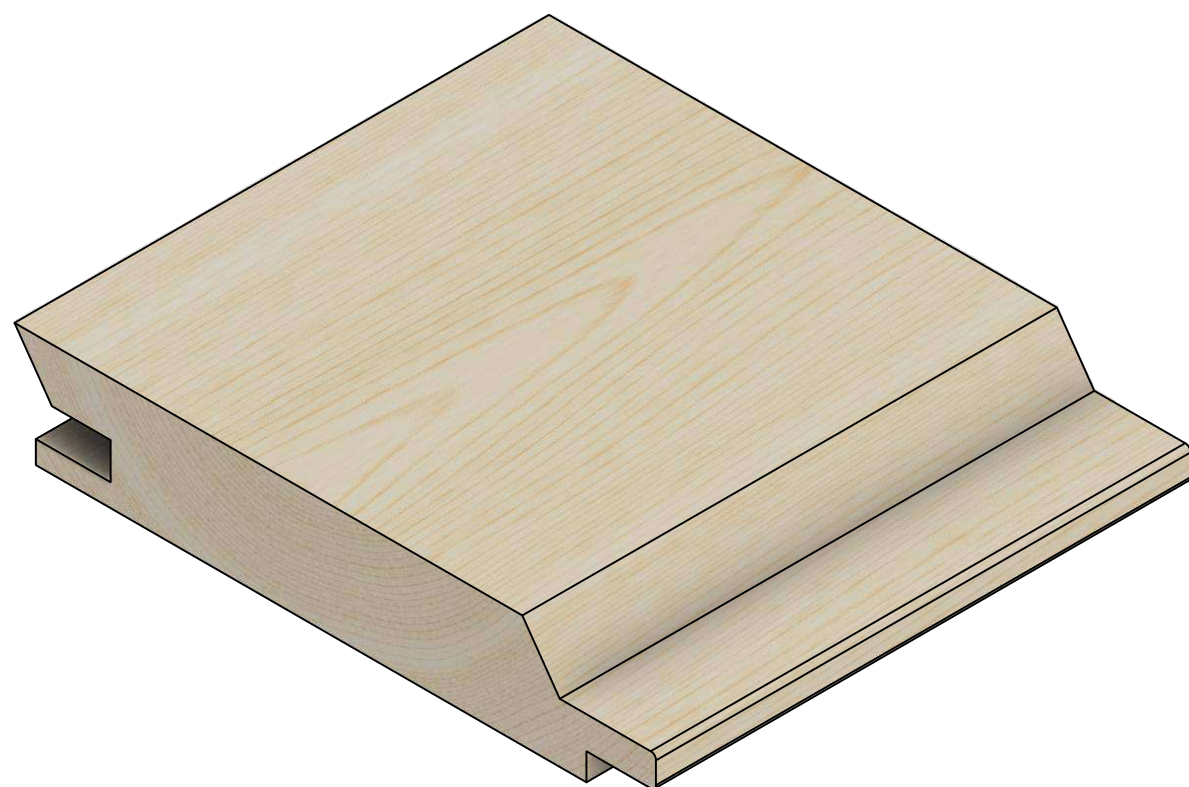
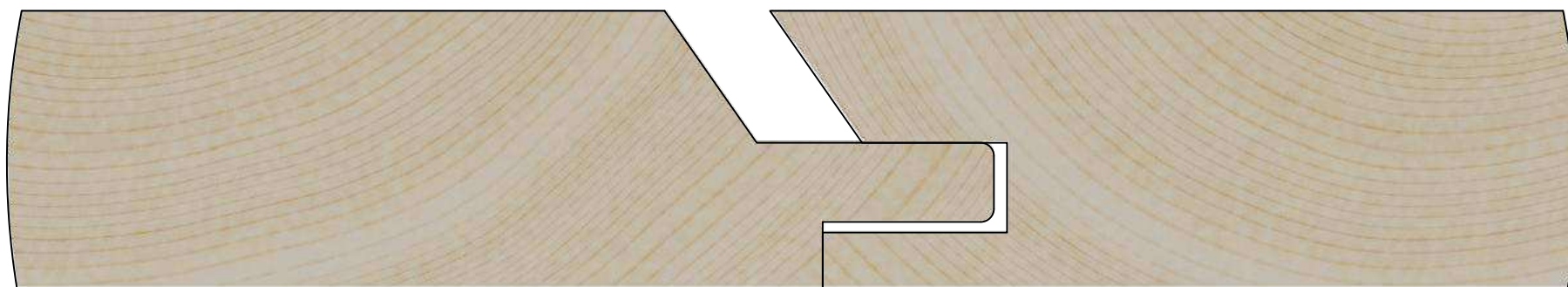
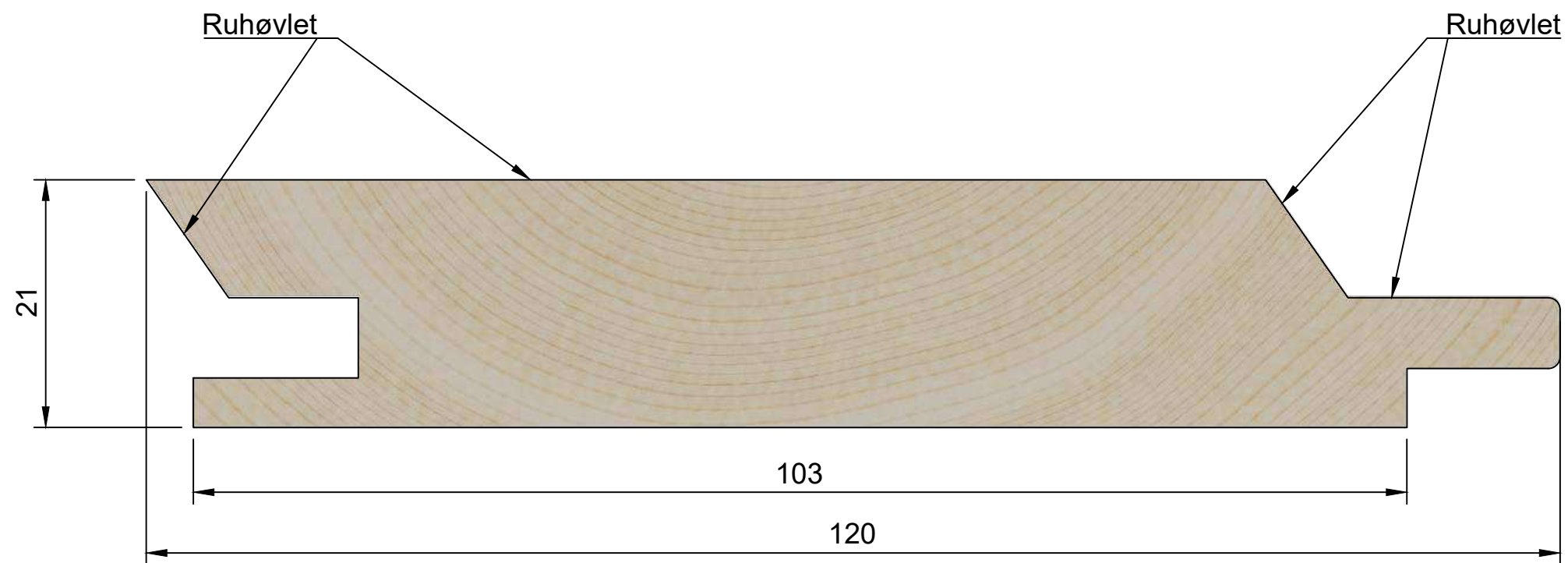

<b>Brandkrav:</b> K1 10 D-s2,d0 opsat på substrat A2-s1,d0 min. densitet 10kg/m3 (Se iøvrigt DoP). Opsættes med højest 25mm bagvedliggende hulrum		Titel: <b>SW01 AART 21x120mm, Salg</b>	
Tegner:	Dato <b>28-10-2020</b>	Godkendt af:	Godkendt dato:
Rev.	Rev. dato	Note: Alle mål er i mm. Tegningen er ikke målfast	Sheet <b>1/1</b>

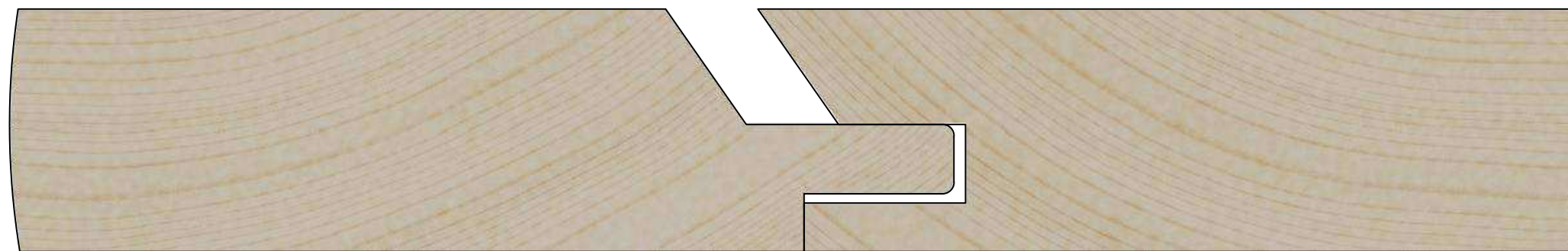
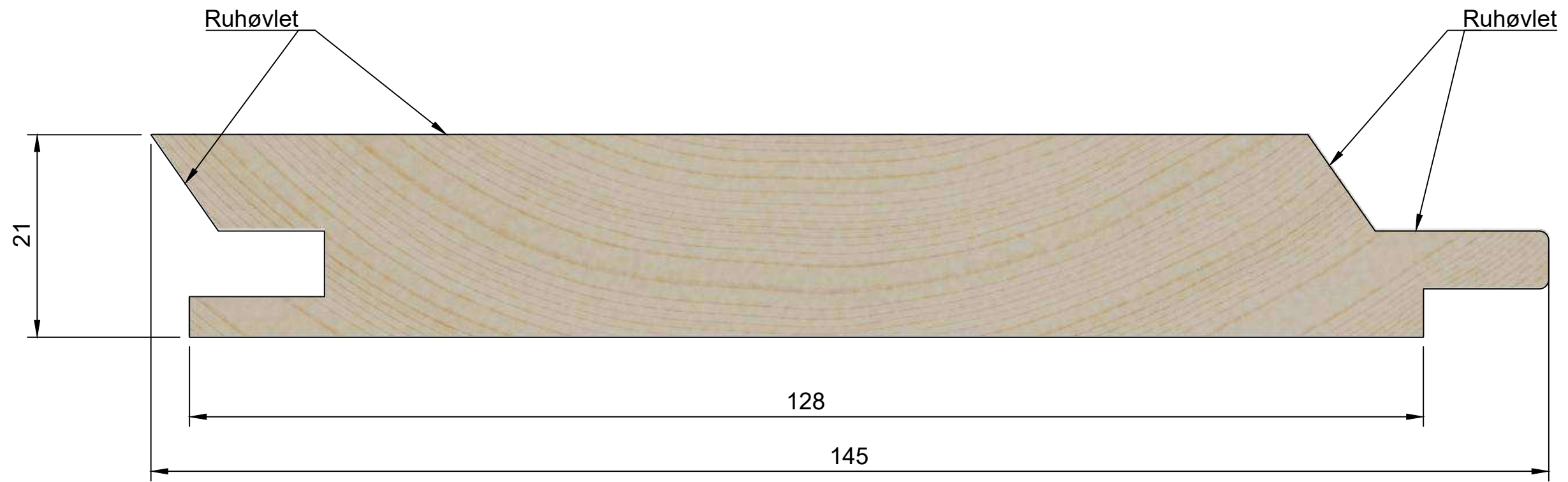

<b>Brandkrav:</b> K1 10 D-s2,d0 opsat på substrat A2-s1,d0 min. densitet 10kg/m3 (Se iøvrigt DoP). Opsættes med højest 25mm bagvedliggende hulrum		Titel: <b>SW01 AART 21x145mm, Salg</b>	
Tegner:	Dato <b>28-10-2020</b>	Godkendt af:	Godkendt dato:
Rev.	Rev. dato	Note: Alle mål er i mm. Tegningen er ikke målfast	Sheet <b>1/1</b>

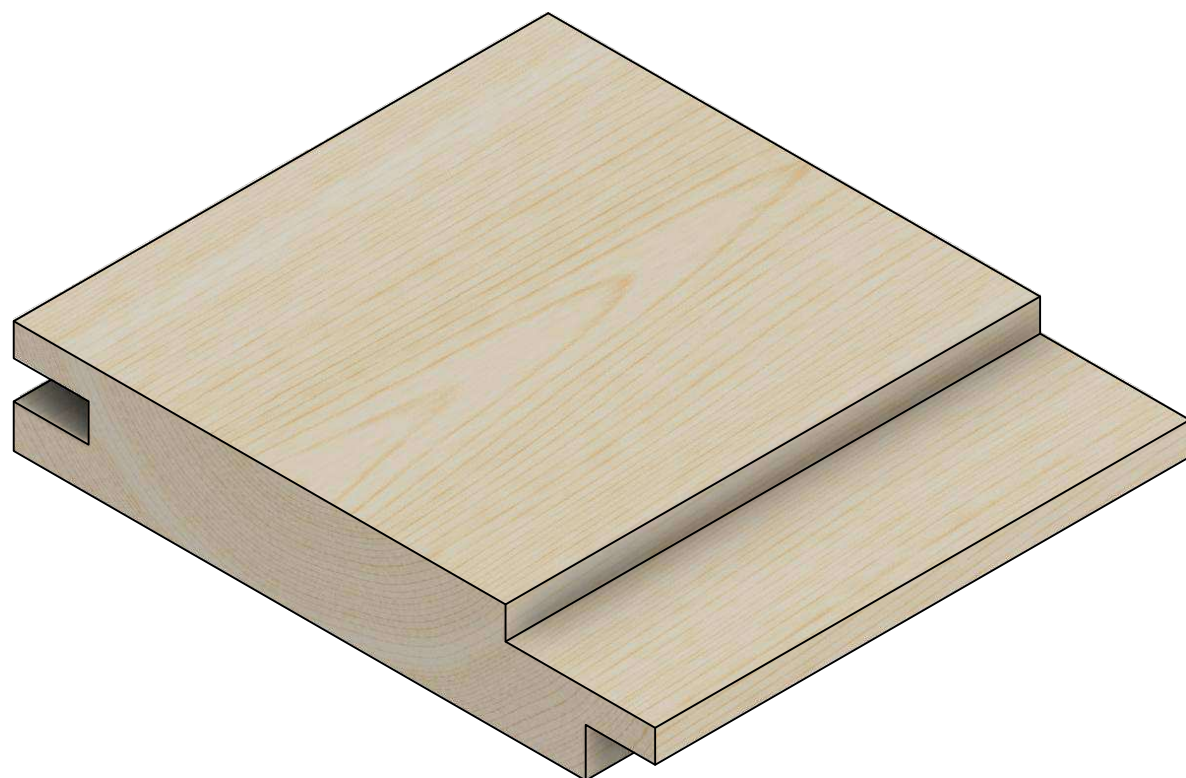
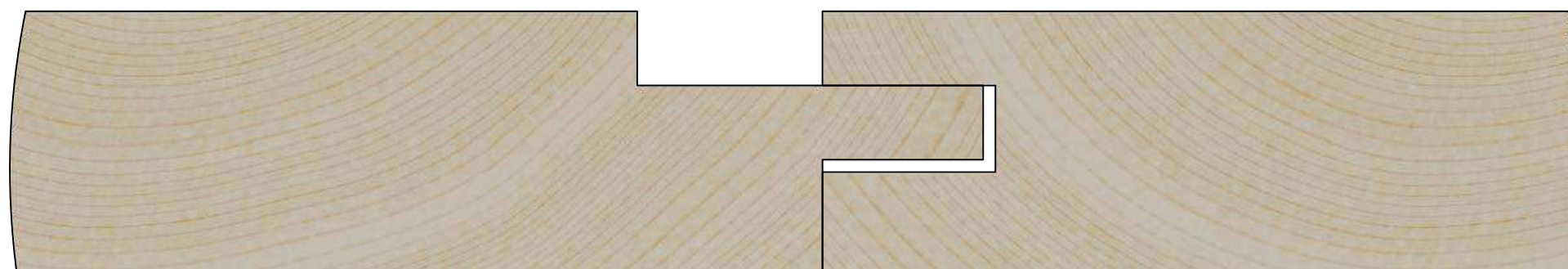
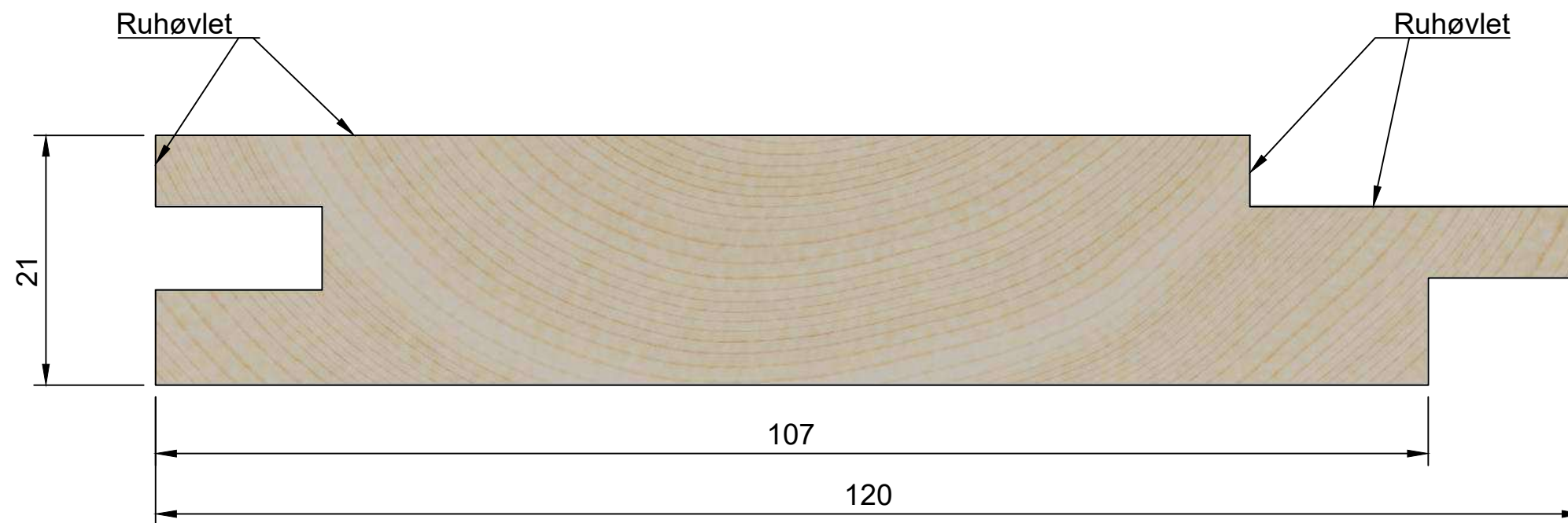

<b>Brandkrav:</b> K1 10 D-s2,d0 opsat på substrat A2-s1,d0 min. densitet 10kg/m3 (Se iverigt DoP).		<b>Titel:</b> SW02 TGU 21x120mm, Salg	
<b>Tegner:</b>	<b>Dato</b> 29-10-2020	<b>Godkendt af:</b>	<b>Godkendt dato:</b>
<b>Rev.</b>	<b>Rev. dato</b>	<b>Note:</b> Alle mål er i mm. Tegningen er ikke målfast	<b>Sheet</b> 1/1

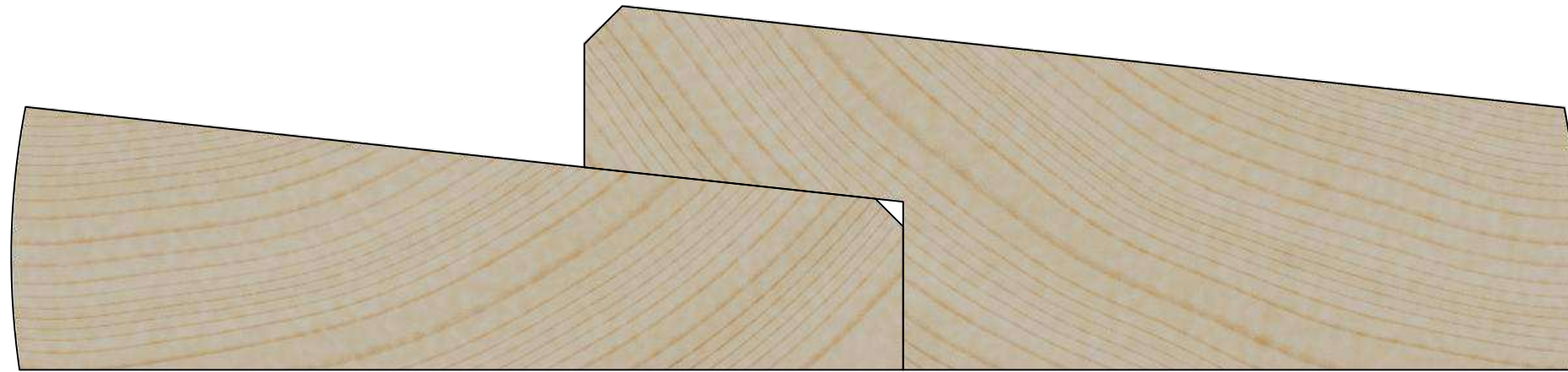
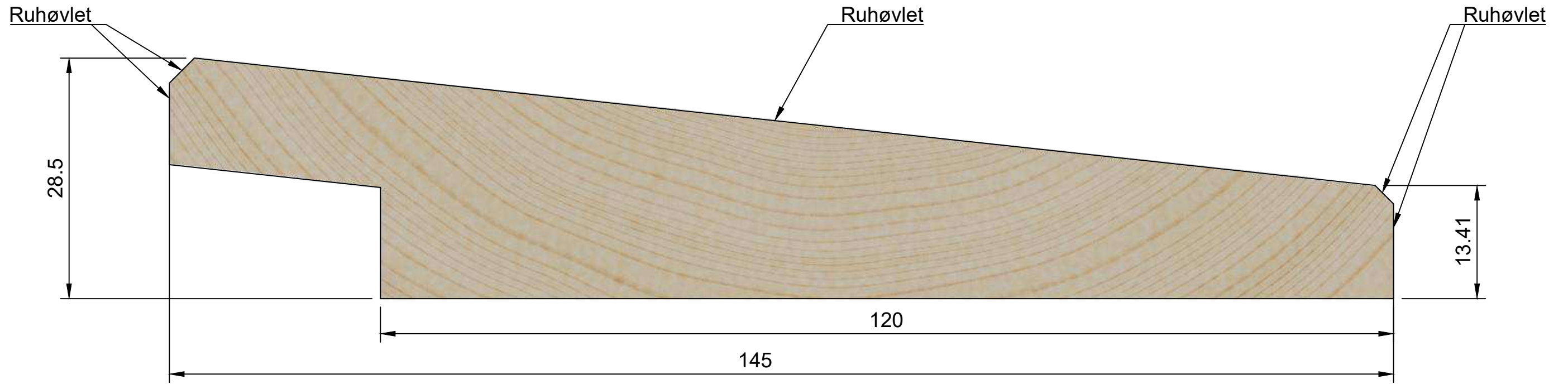

Brandkrav: D-s2,d0 (Se iøvrigt DoP).		Titel: SW03 Klink 21x145mm, Salg	
Tegner:	Dato 03-11-2020	Godkendt af:	Godkendt dato:
Rev.	Rev. dato	Note: Alle mål er i mm. Tegningen er ikke målfast	Sheet 1/1

Ruhøvlet 4 sider

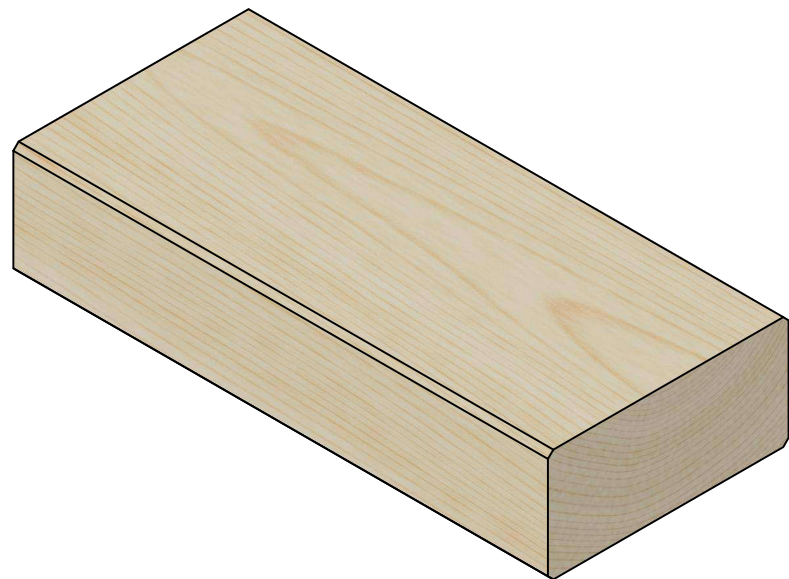
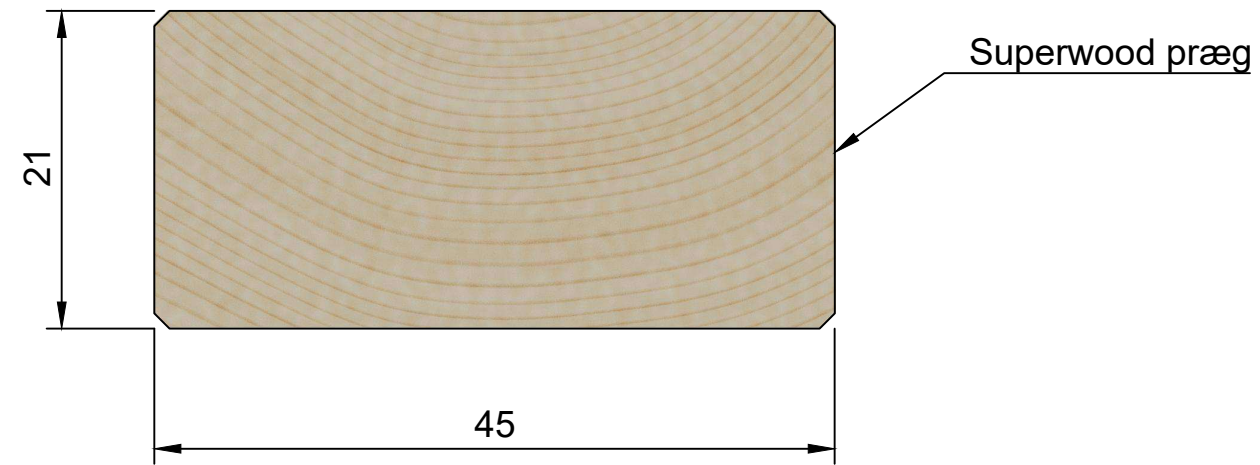

Brandkrav: D-s2,d0 (Se iøvrigt DoP).		Titel: SW04 Ruhøvlet 21x45mm, Salg	
Tegner:	Dato 03-11-2020	Godkendt af:	Godkendt dato:
Rev.	Rev. dato	Note: Alle mål er i mm. Tegningen er ikke målfast	Sheet 1/1

Ruhøvlet 4 sider

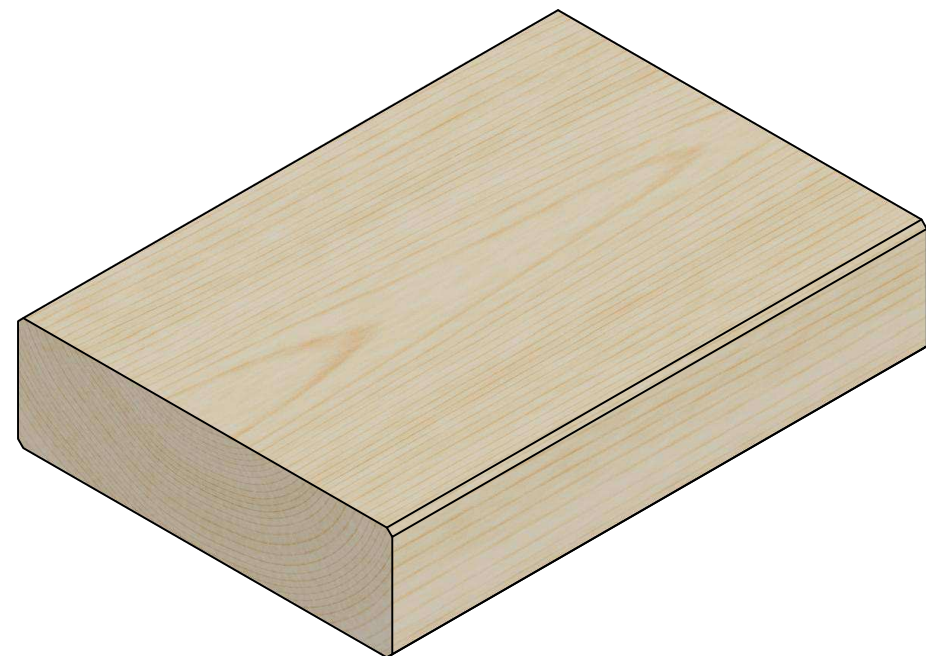
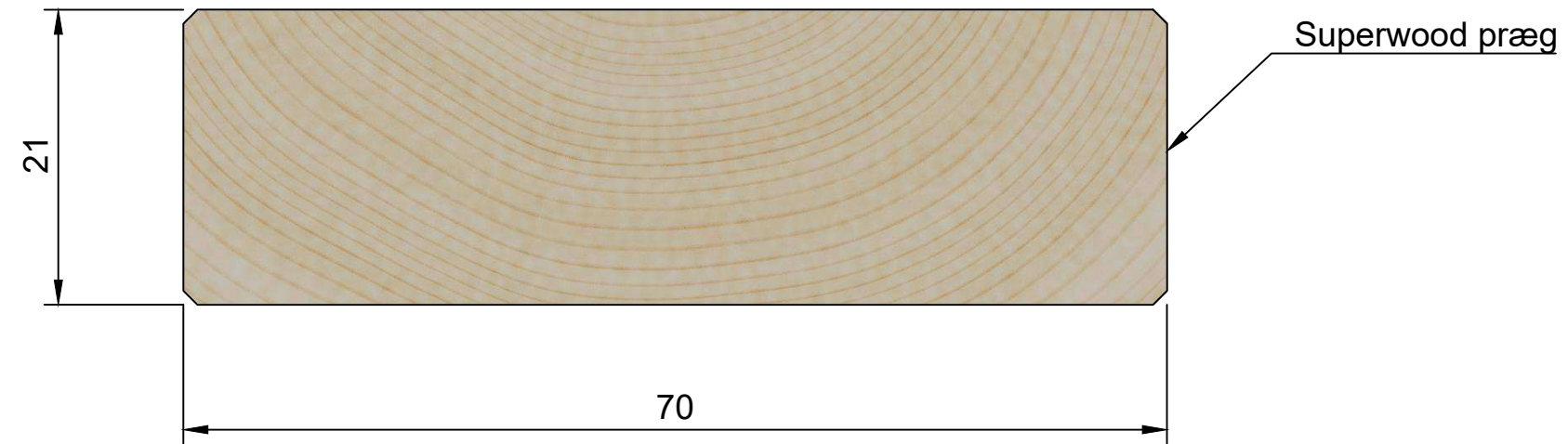

Brandkrav: D-s2,d0 (Se iøvrigt DoP).		Titel: SW04 Ruhøvlet 21x70mm, Salg	
Tegner:	Dato 03-11-2020	Godkendt af:	Godkendt dato:
Rev.	Rev. dato	Note: Alle mål er i mm. Tegningen er ikke målfast	Sheet 1/1



Ruhøvlet 4 sider

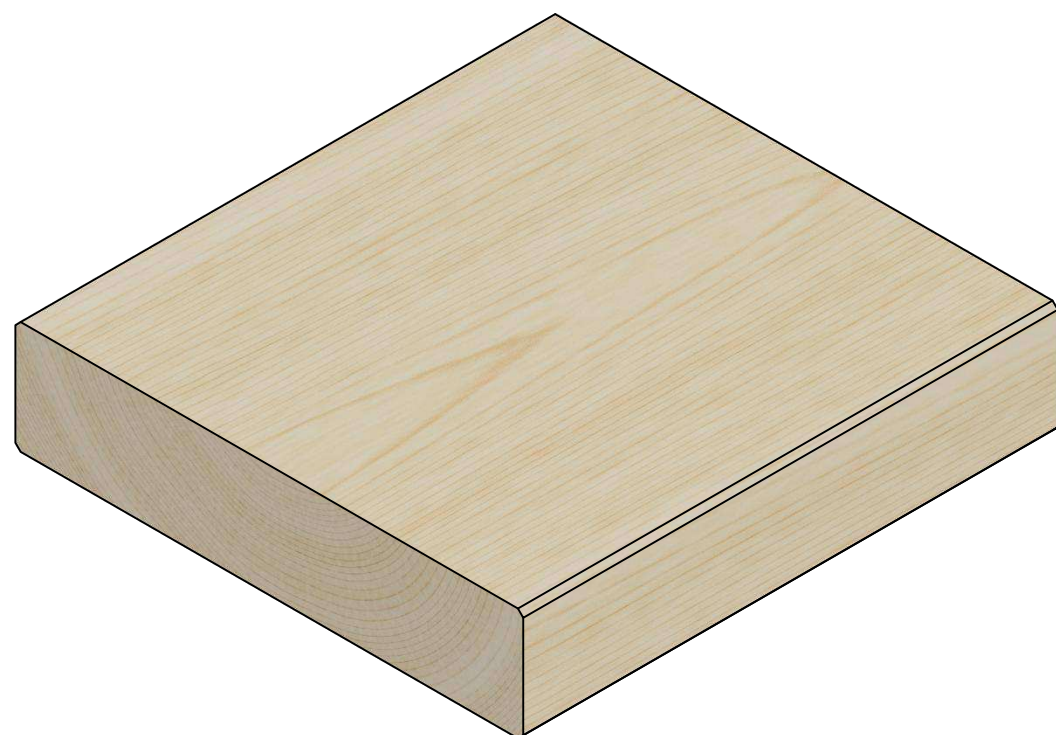
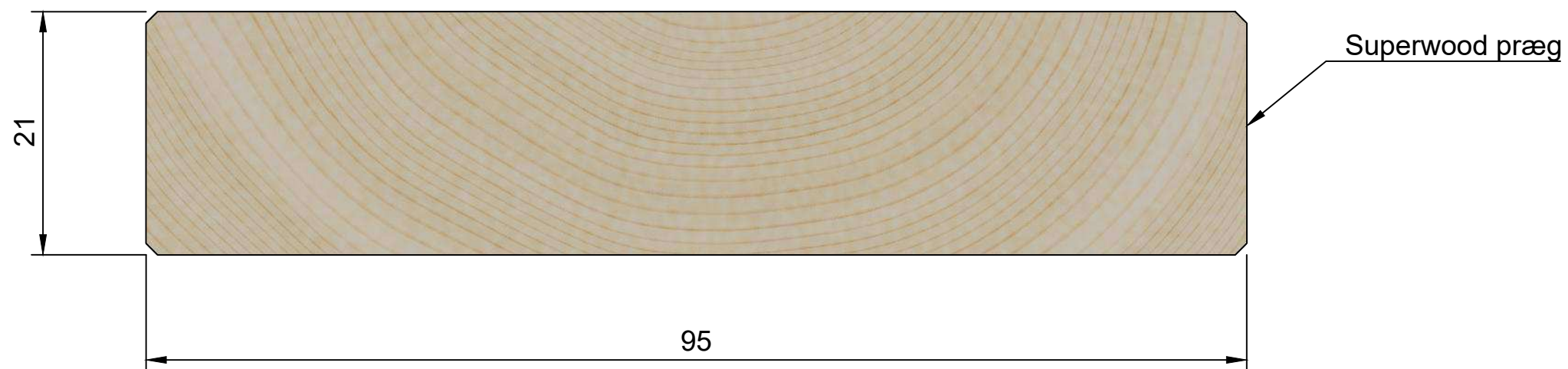

Brandkrav: D-s2,d0 (Se iøvrigt DoP).		Titel: SW04 Ruhøvlet 21x95mm, Salg	
Tegner:	Dato 03-11-2020	Godkendt af:	Godkendt dato:
Rev.	Rev. dato	Note: Alle mål er i mm. Tegningen er ikke målfast	Sheet 1/1

Ruhøvlet 4 sider

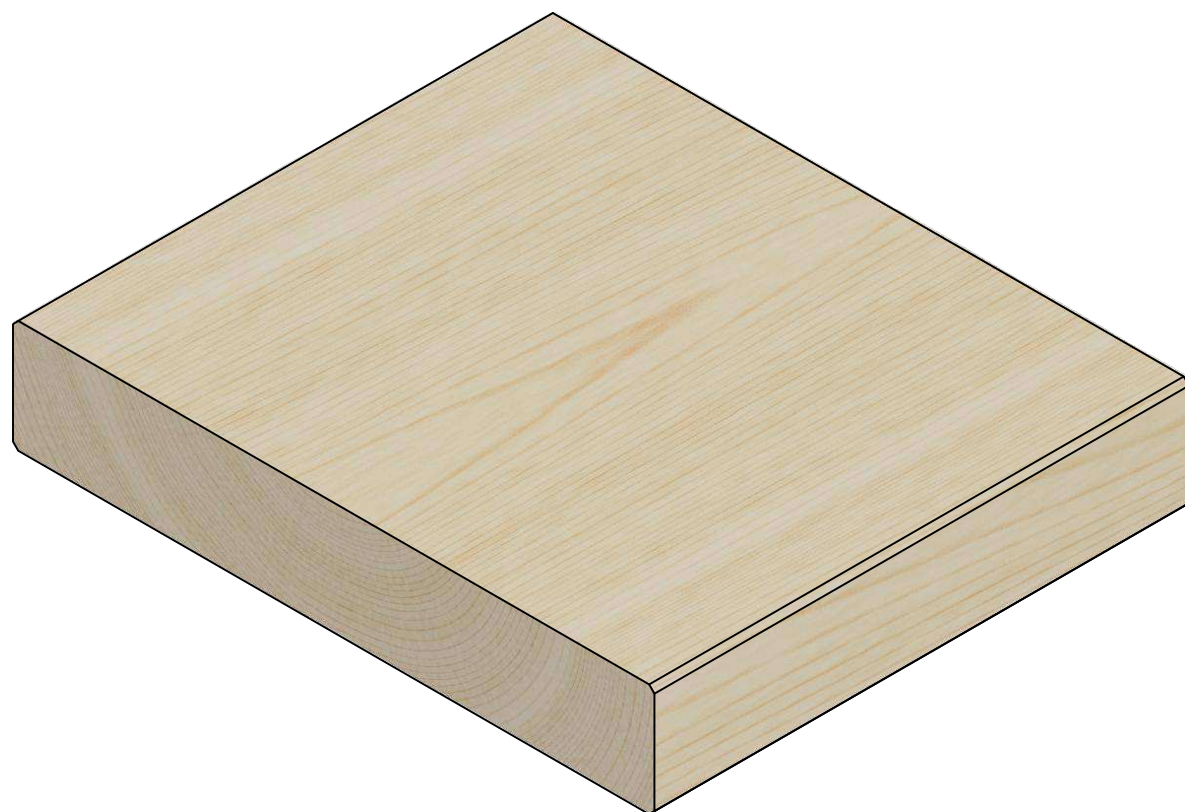
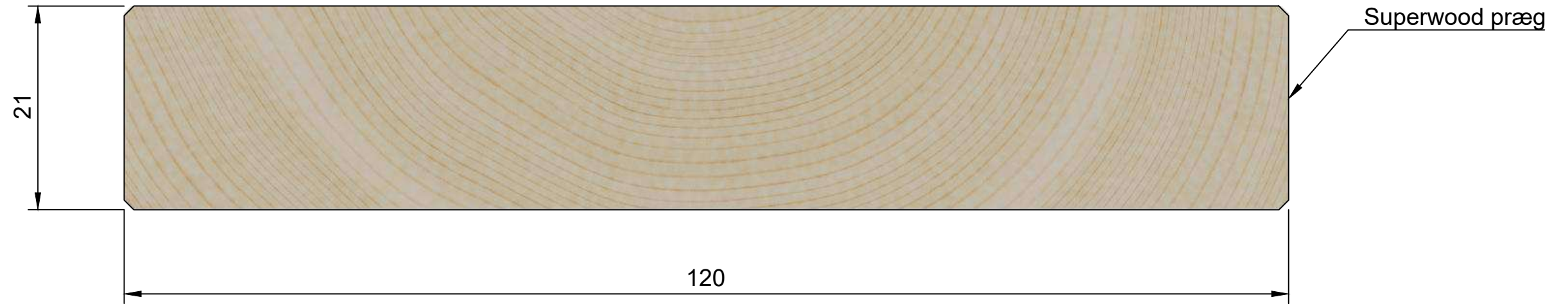

Brandkrav: D-s2,d0 (Se iøvrigt DoP).		Titel: SW04 Ruhøvlet 21x120mm, Salg	
Tegner:	Dato 03-11-2020	Godkendt af:	Godkendt dato:
Rev.	Rev. dato	Note: Alle mål er i mm, Tegningen er ikke målfast	Sheet 1/1

Ruhøvlet 4 sider

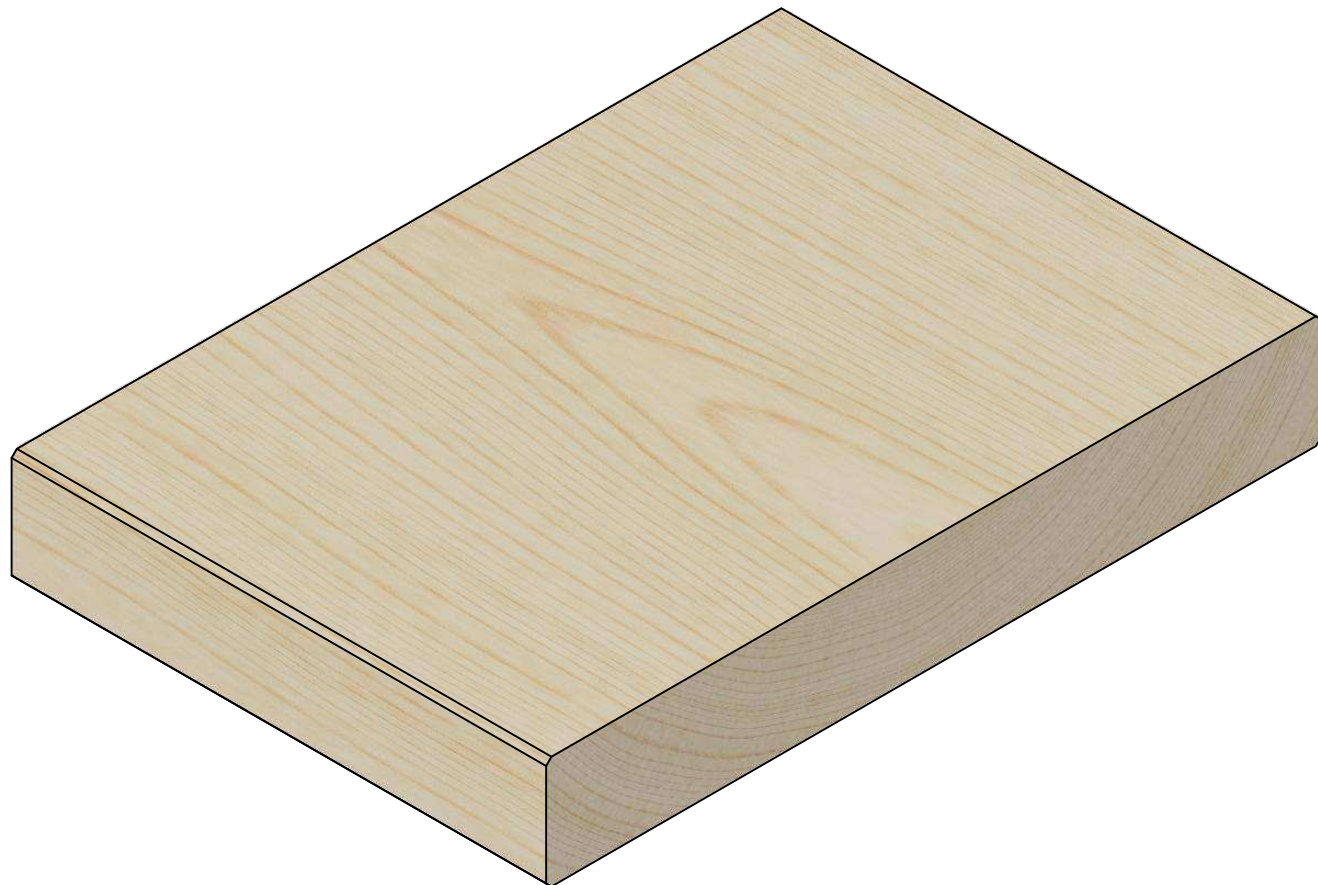
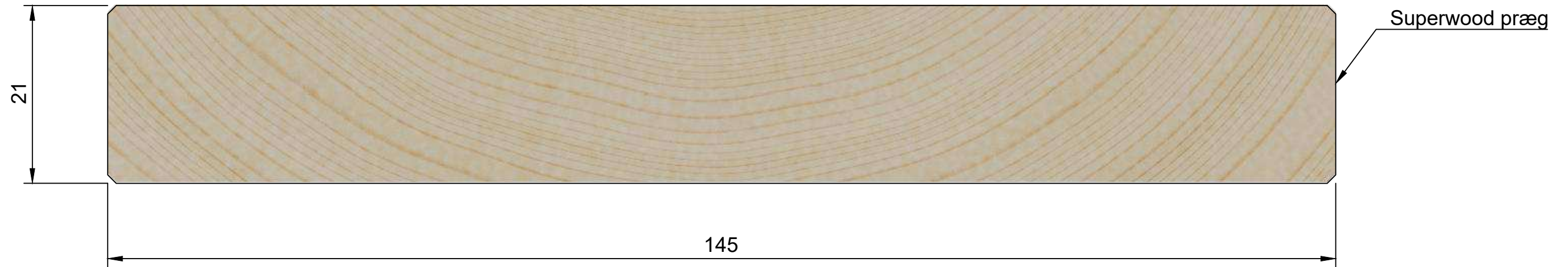

			
Brandkrav: D-s2,d0 (Se iøvrigt DoP).		Titel: SW04 Ruhøvlet 21x145mm, Salg	
Tegner:	Dato 03-11-2020	Godkendt af:	Godkendt dato:
Rev.	Rev. dato	Note: Alle mål er i mm. Tegningen er ikke målfast	Sheet 1/1

Ruhøvlet 4 sider

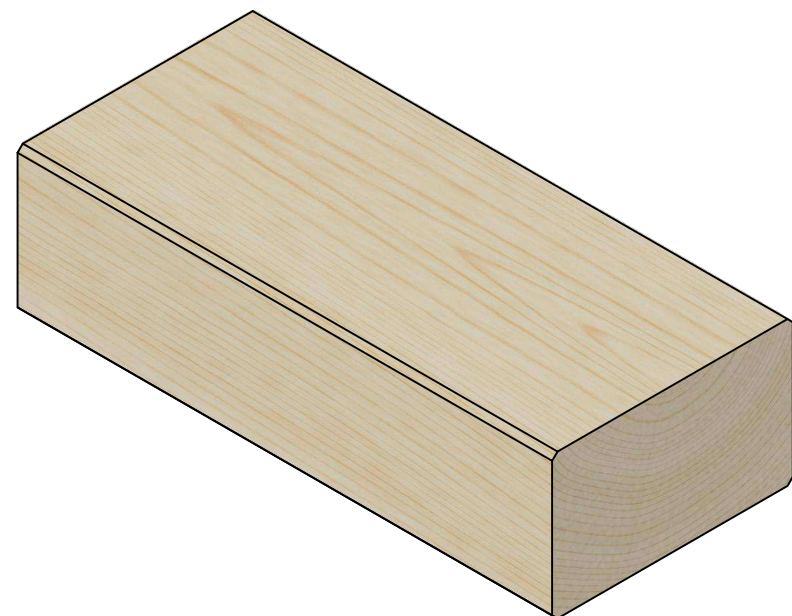
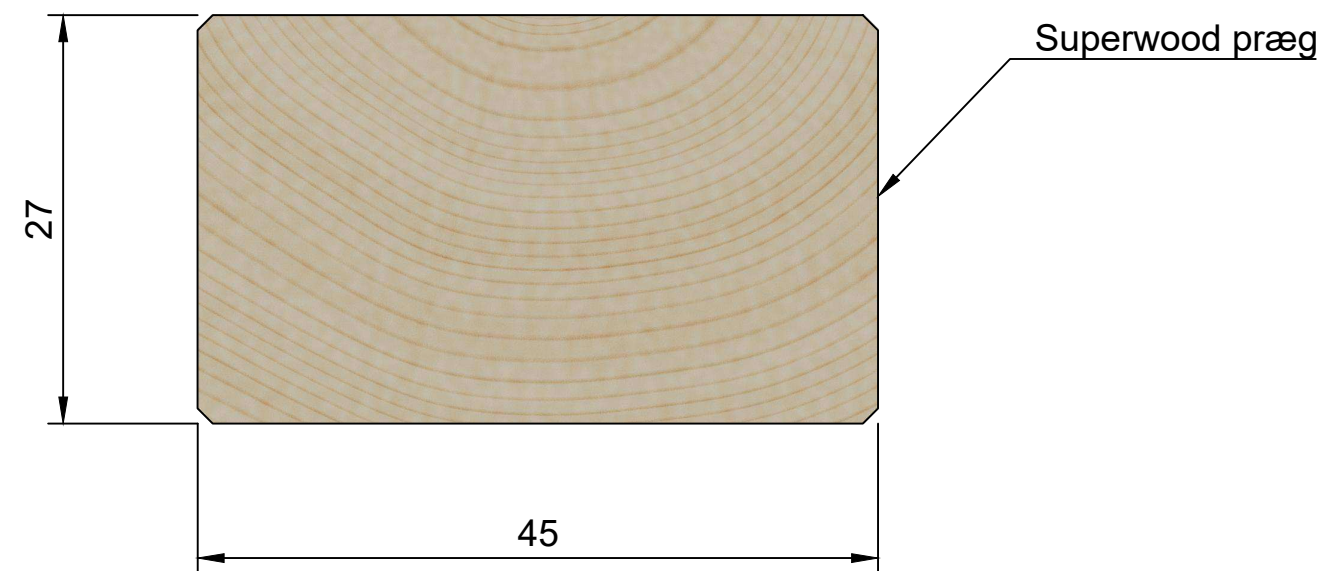

Brandkrav: D-s2,d0 (Se iøvrigt DoP).		Titel: SW04 Ruhøvlet 27x45mm, Salg	
Tegner:	Dato 04-11-2020	Godkendt af:	Godkendt dato:
Rev.	Rev. dato	Note: Alle mål er i mm. Tegningen er ikke målfast	Sheet 1/1

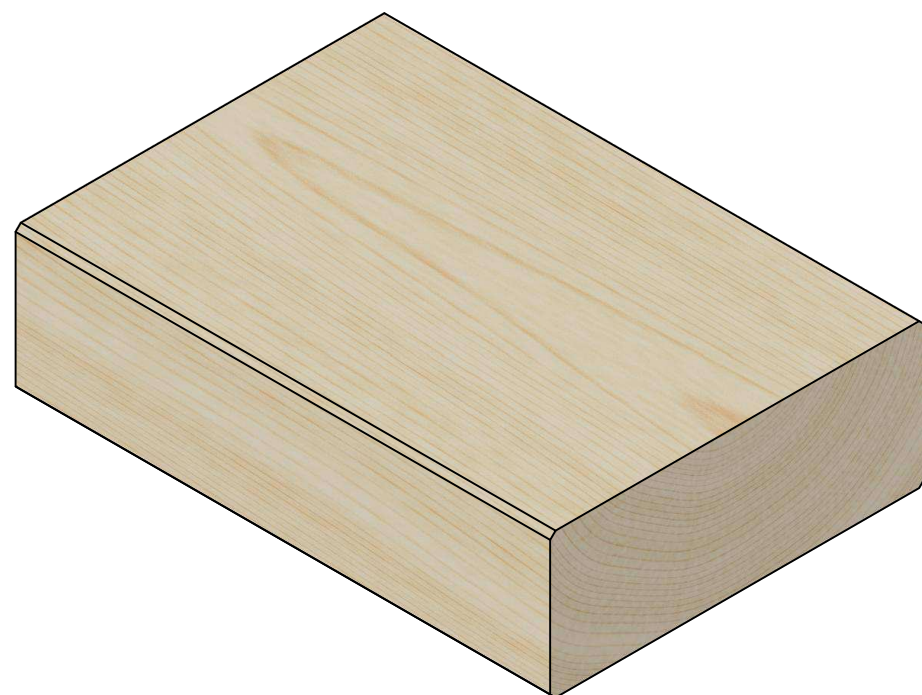
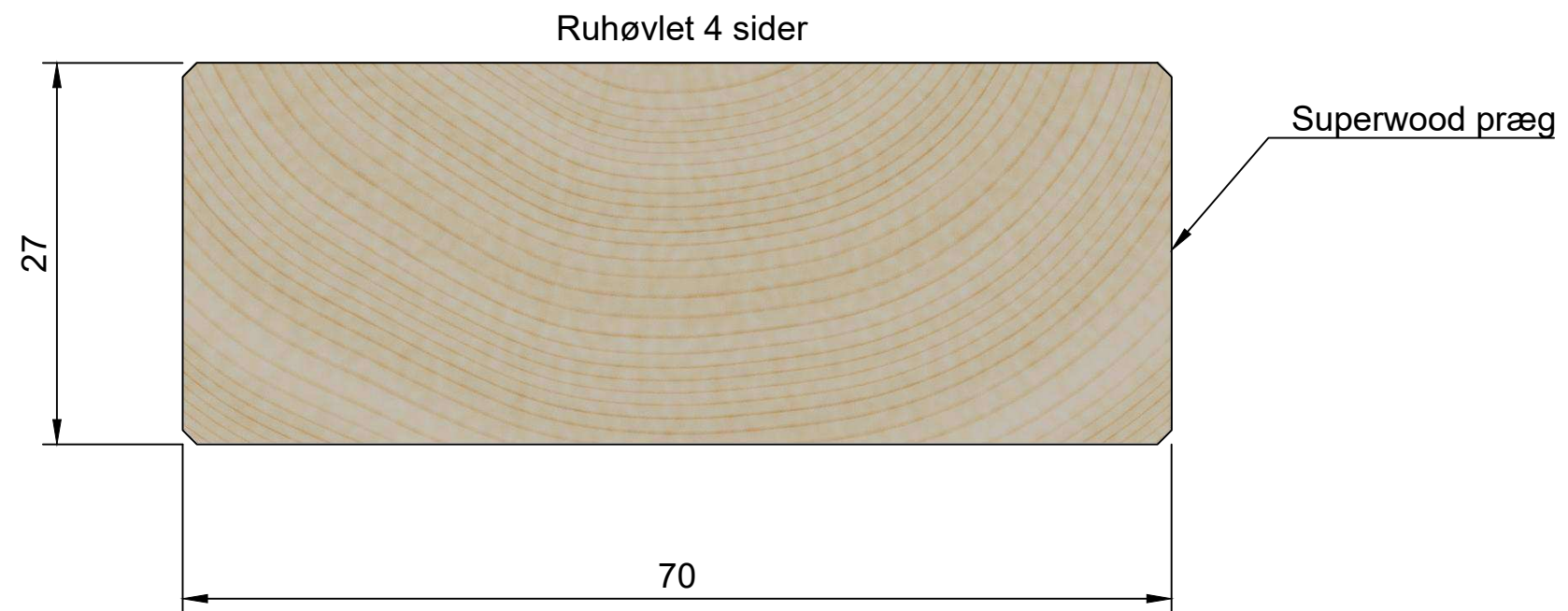

			
Brandkrav: D-s2,d0 (Se iøvrigt DoP).		Titel: SW04 Ruhøvlet 27x70mm, Salg	
Tegner:	Dato 05-11-2020	Godkendt af:	Godkendt dato:
Rev.	Rev. dato	Note: Alle må er i mm. Tegningen er ikke målfast	Sheet 1/1

Ruhøvlet 4 sider

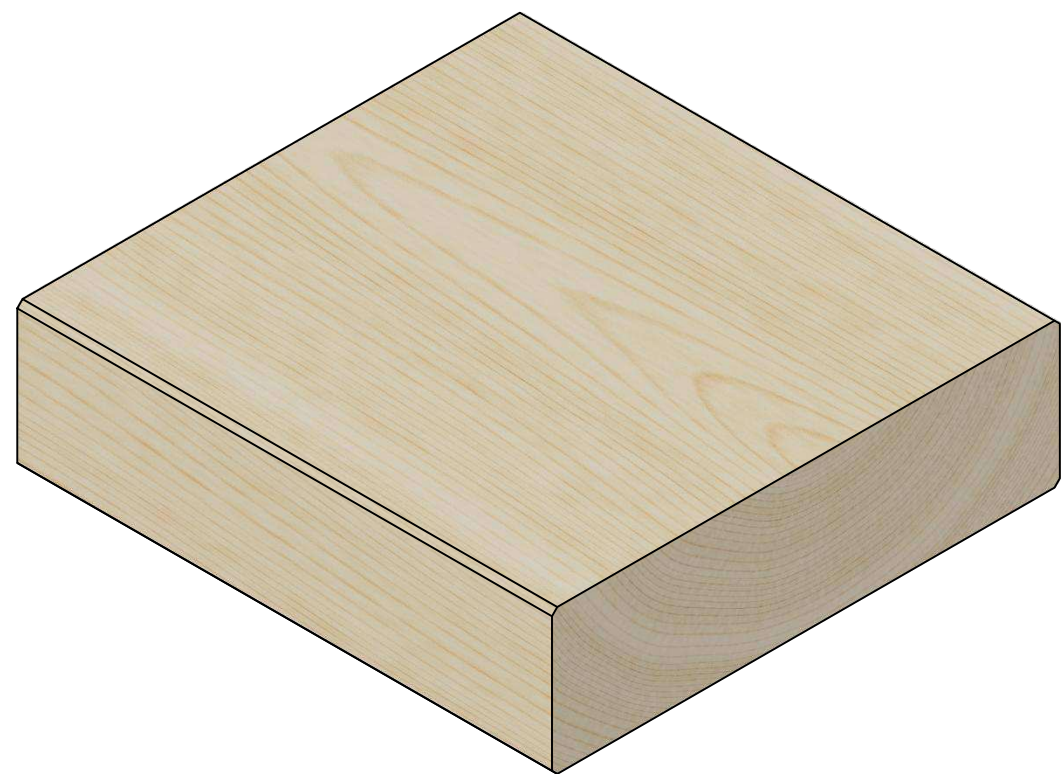
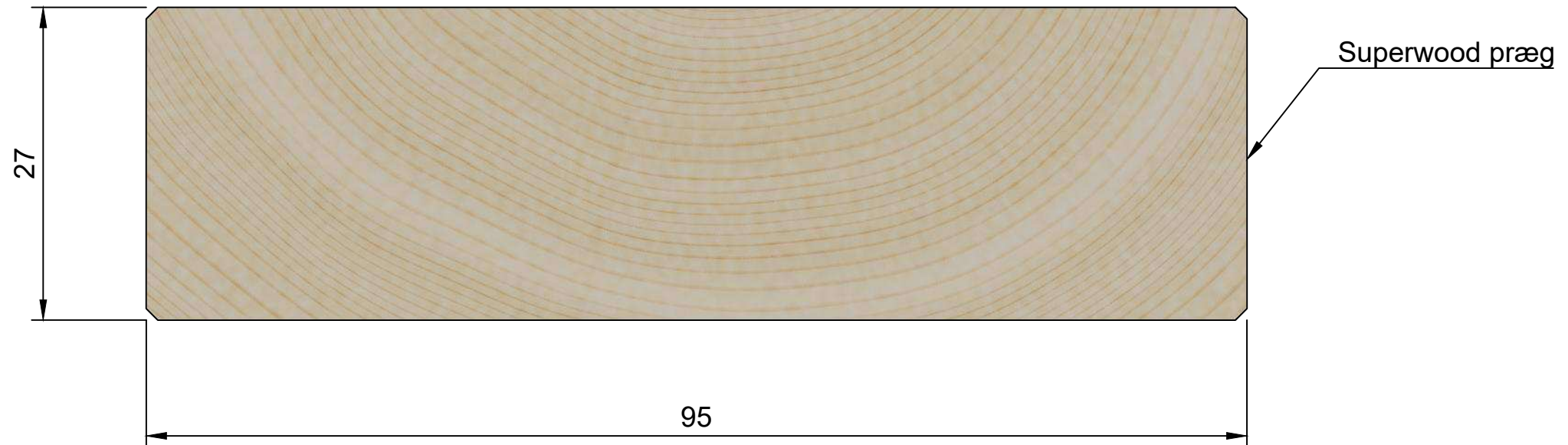

Brandkrav: D-s2,d0 (Se iøvrigt DoP).		Titel: SW04 Ruhøvlet 27x95mm, Salg	
Tegner:	Dato 05-11-2020	Godkendt af:	Godkendt dato:
Rev.	Rev. dato	Note: Alle mål er i mm. Tegningen er ikke målfast	Sheet 1/1

Ruhøvlet 4 sider

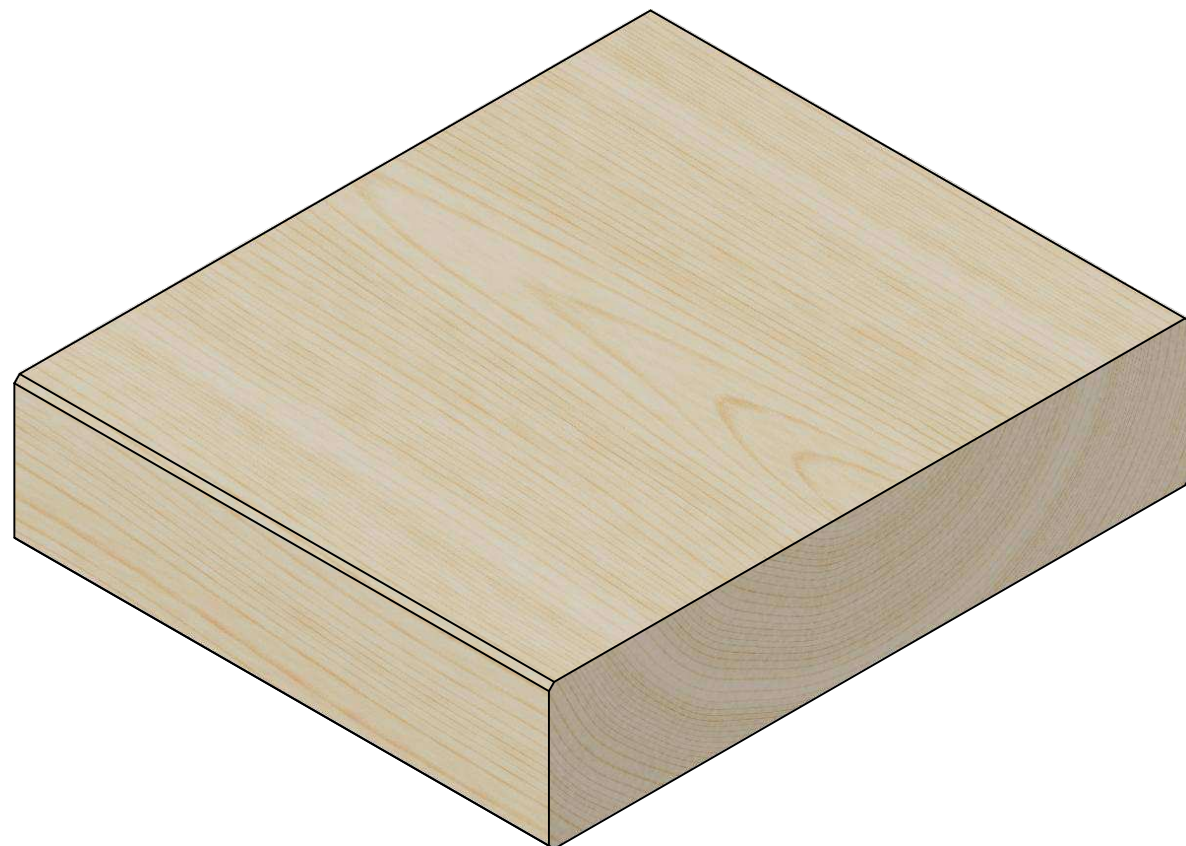
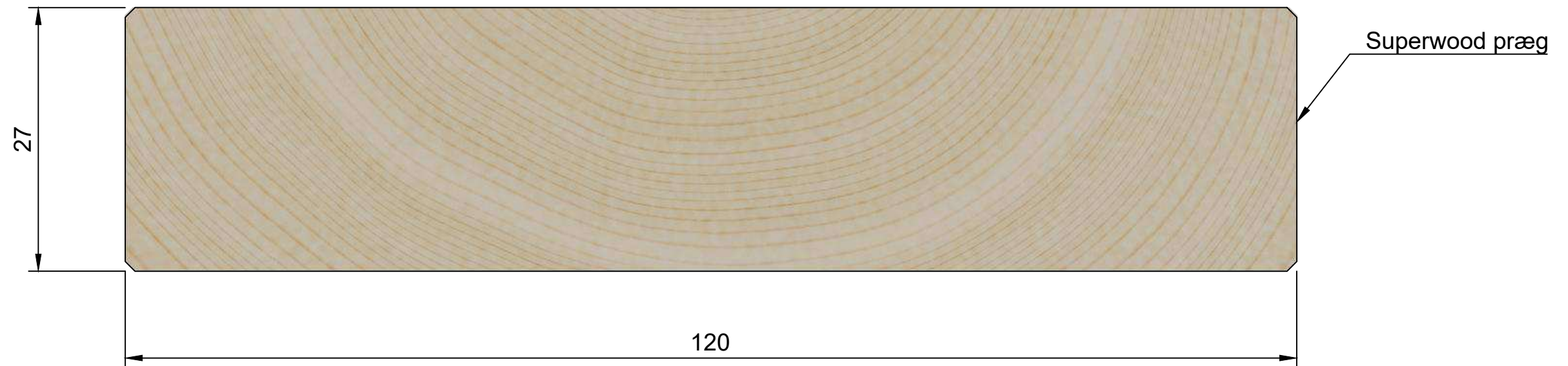

			
Brandkrav: D-s2,d0 (Se iøvrigt DoP).		Titel: SW04 Ruhøvlet 27x120mm, Salg	
Tegner:	Dato 05-11-2020	Godkendt af:	Godkendt dato:
Rev.	Rev. dato	Note: Alle mål er i mm. Tegningen er ikke målfast	Sheet 1/1

Ruhøvlet 4 sider

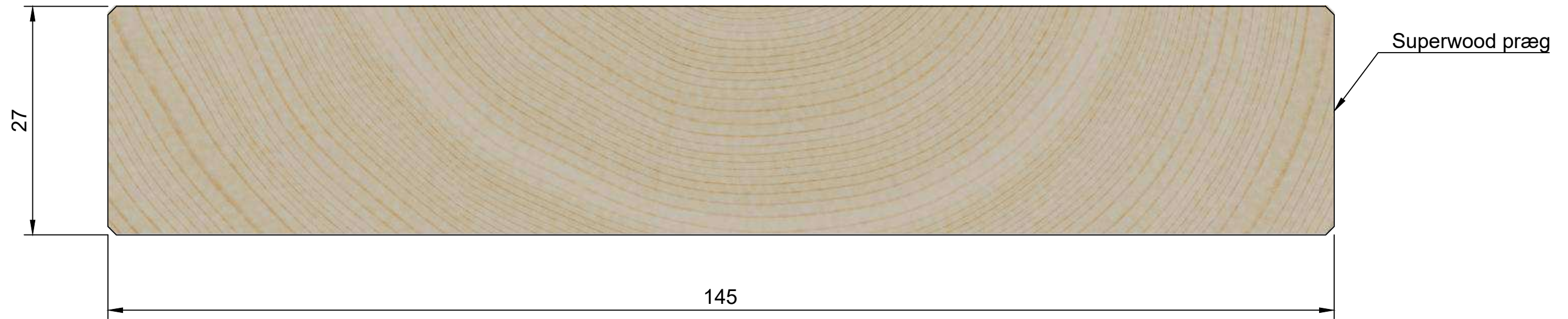

Brandkrav: D-s2,d0 (Se iøvrigt DoP).		Titel: SW04 Ruhøvlet 27x145mm, Salg	
Tegner:	Dato 05-11-2020	Godkendt af:	Godkendt dato:
Rev.	Rev. dato	Note: Alle mål er i mm. Tegningen er ikke målfast	Sheet 1/1



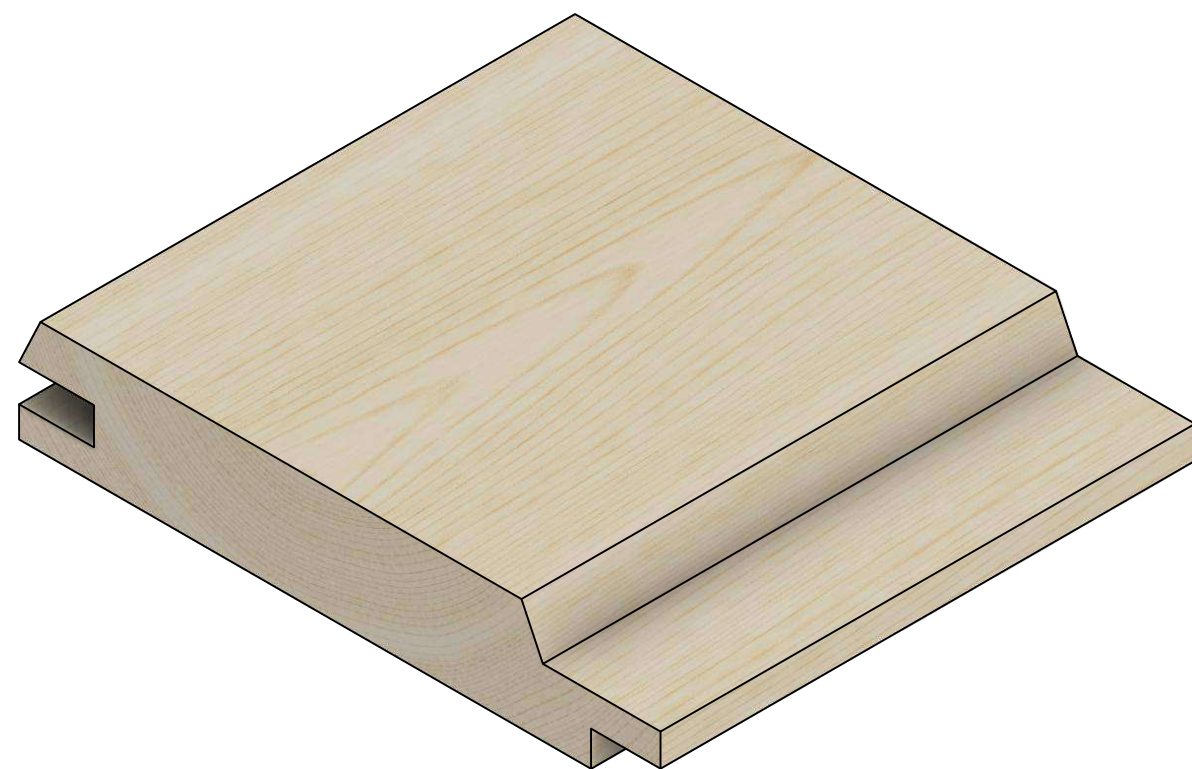
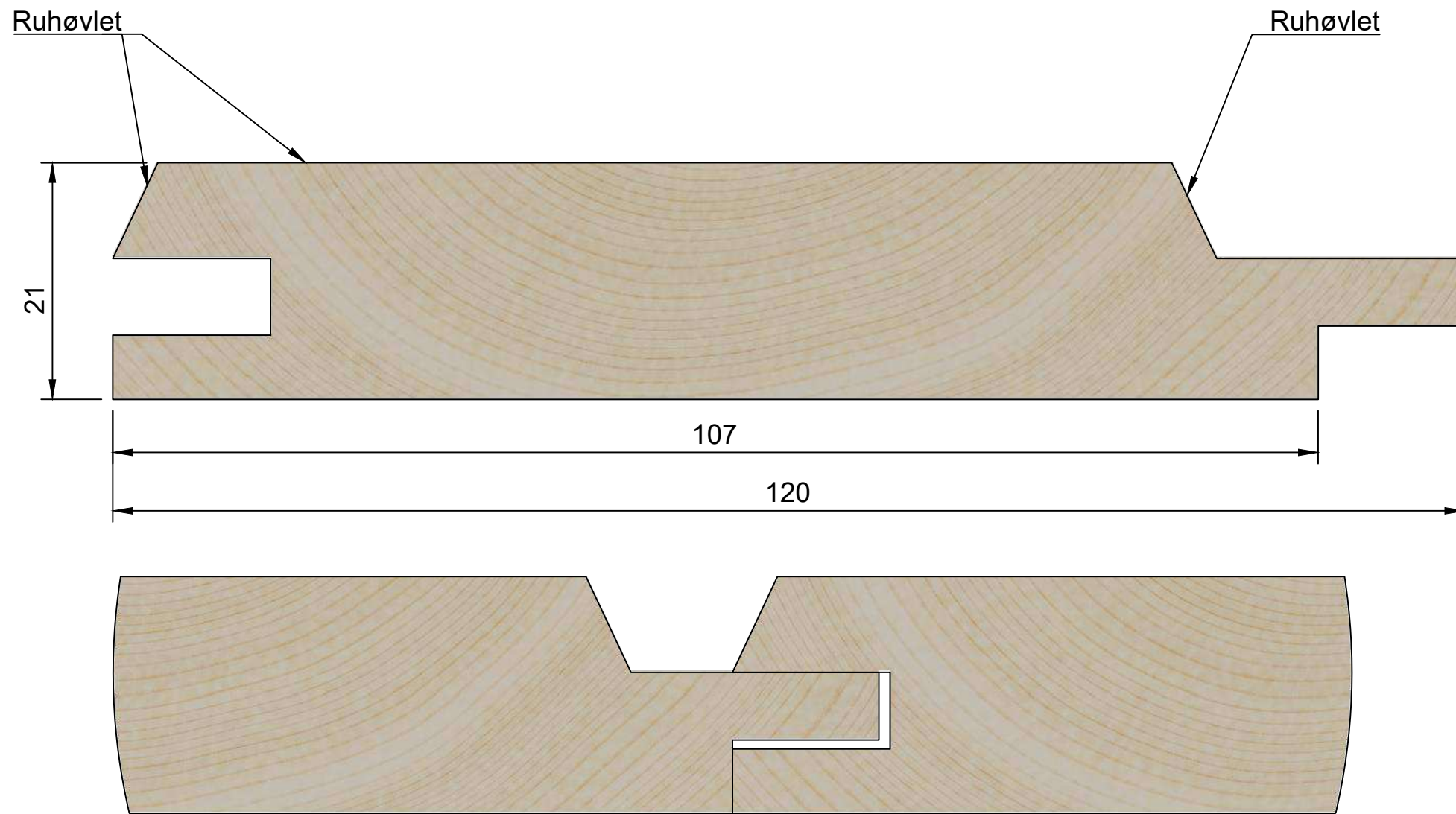

			
<b>Brandkrav:</b> K1 10 D-s2,d0 opsat på substrat A2-s1,d0 min. densitet 10kg/m3 (Se iverigt DoP).		<b>Titel:</b> SW06 Mellemstern 21x120mm, Salg	
<b>Tegner:</b>	<b>Dato</b> 06-11-2020	<b>Godkendt af:</b>	<b>Godkendt dato:</b>
<b>Rev.</b>	<b>Rev. dato</b>	<b>Note:</b> Alle mål er i mm. Tegningen er ikke målfast	<b>Sheet</b> 1/1

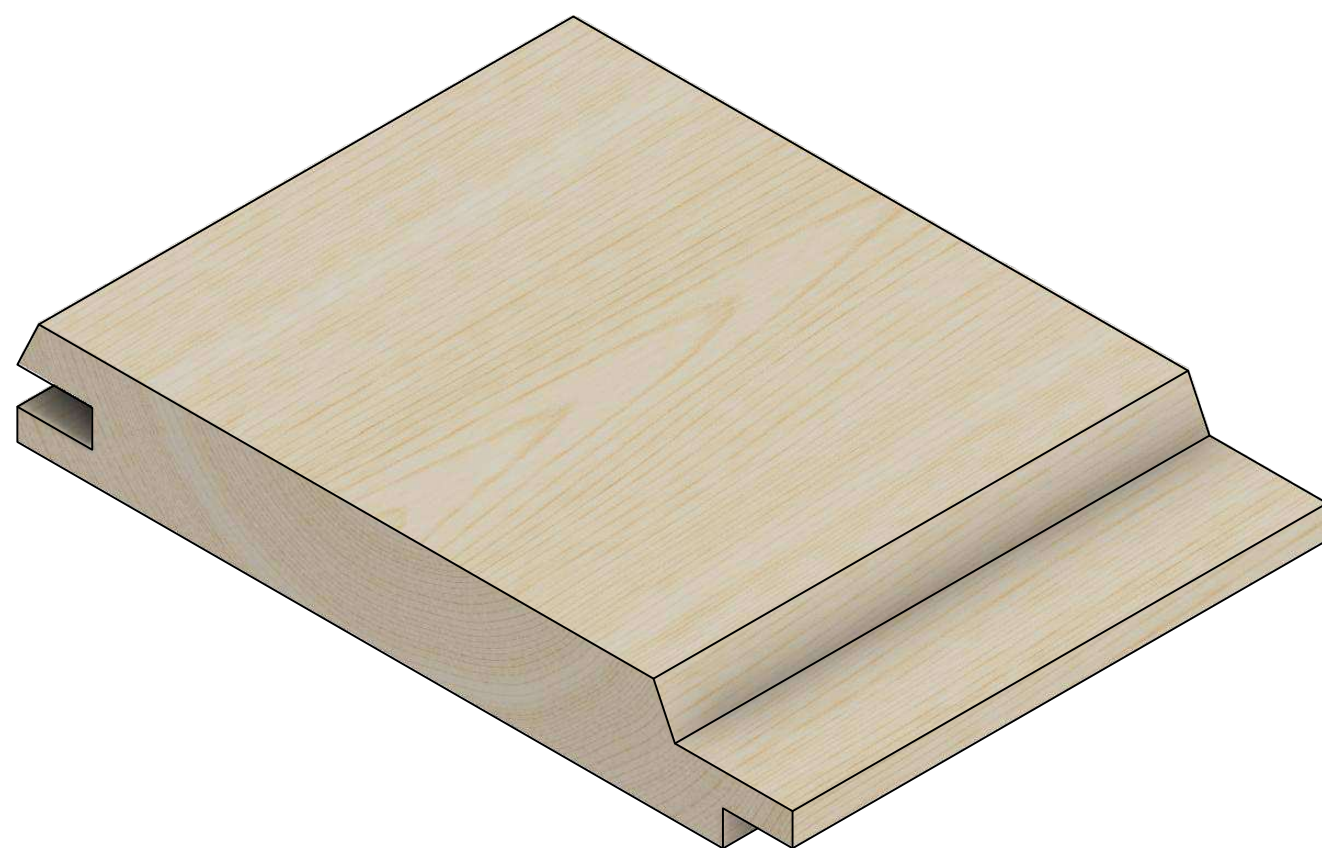
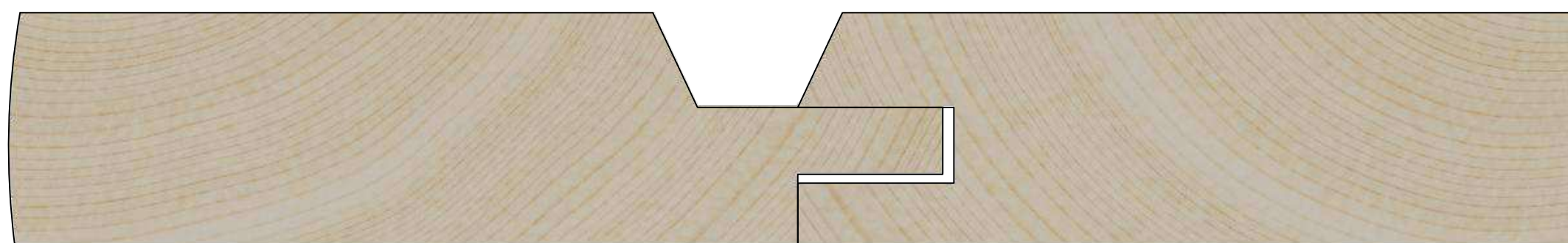
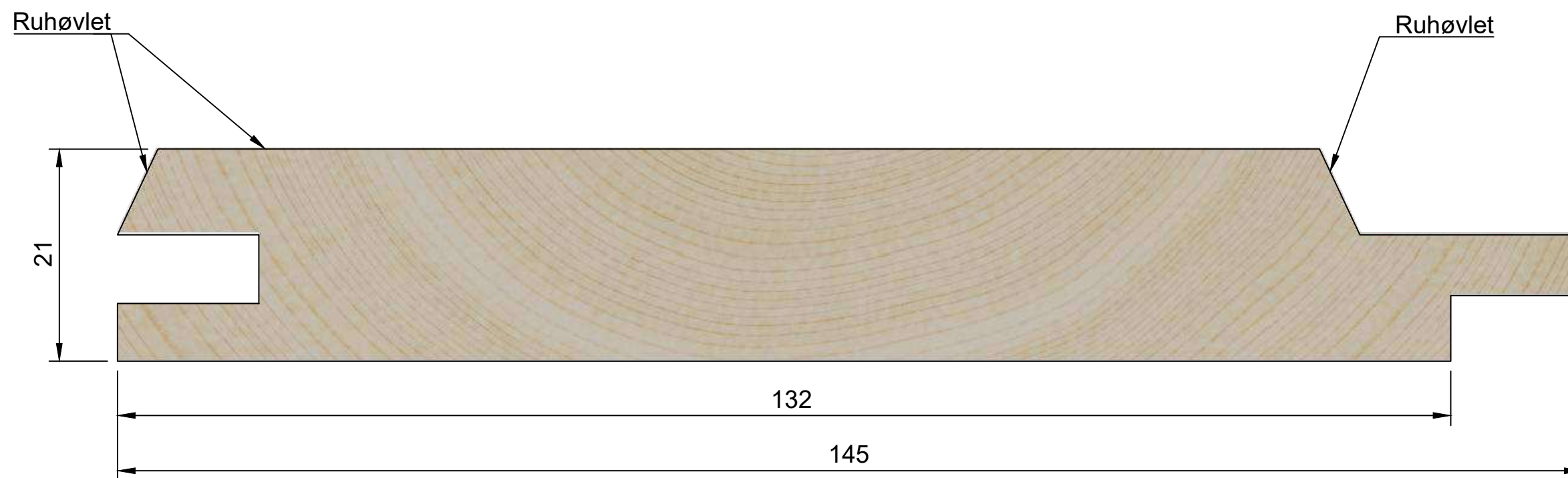

<b>Brandkrav:</b> K1 10 D-s2,d0 opsat på substrat A2-s1,d0 min. densitet 10kg/m3 (Se iøvrigt DoP).		<b>Titel:</b> SW06 Mellemstern 21x145mm, Salg	
<b>Tegner:</b>	<b>Dato</b> 06-11-2020	<b>Godkendt af:</b>	<b>Godkendt dato:</b>
<b>Rev.</b>	<b>Rev. dato</b>	<b>Note:</b> Alle mål er i mm. Tegningen er ikke målfast	<b>Sheet</b> 1/1

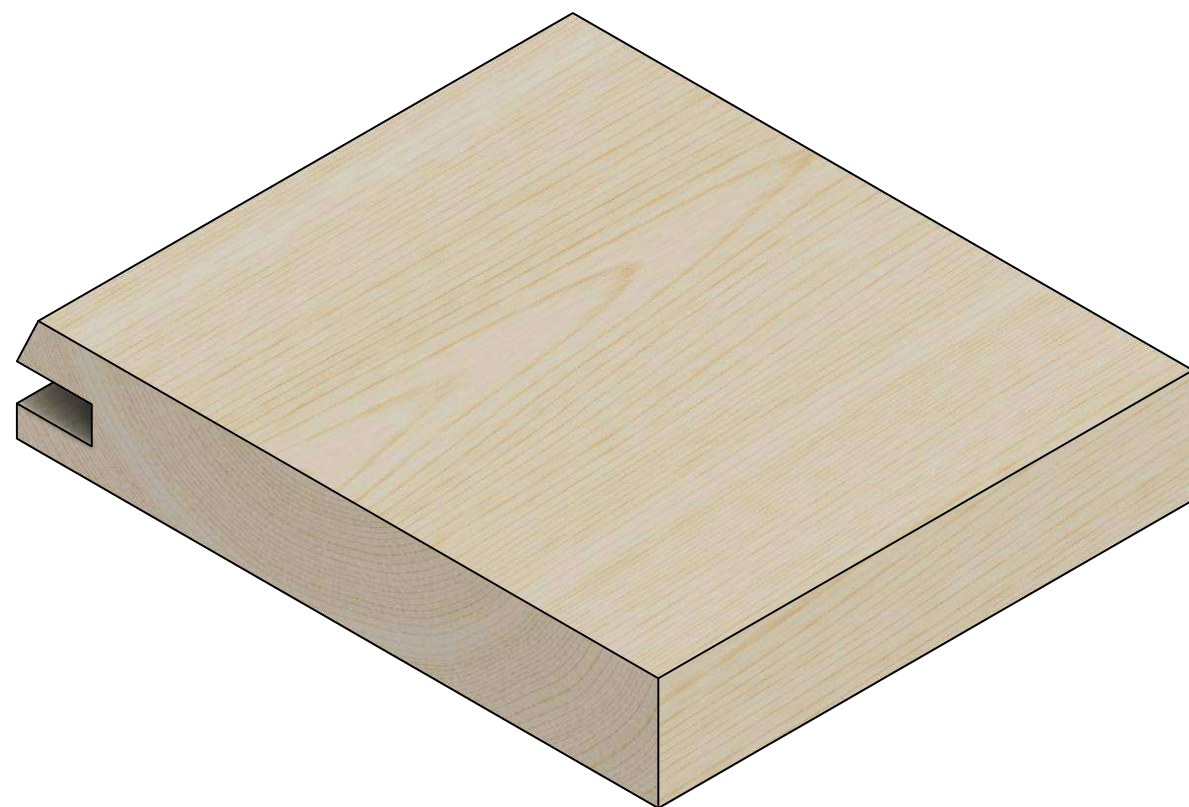
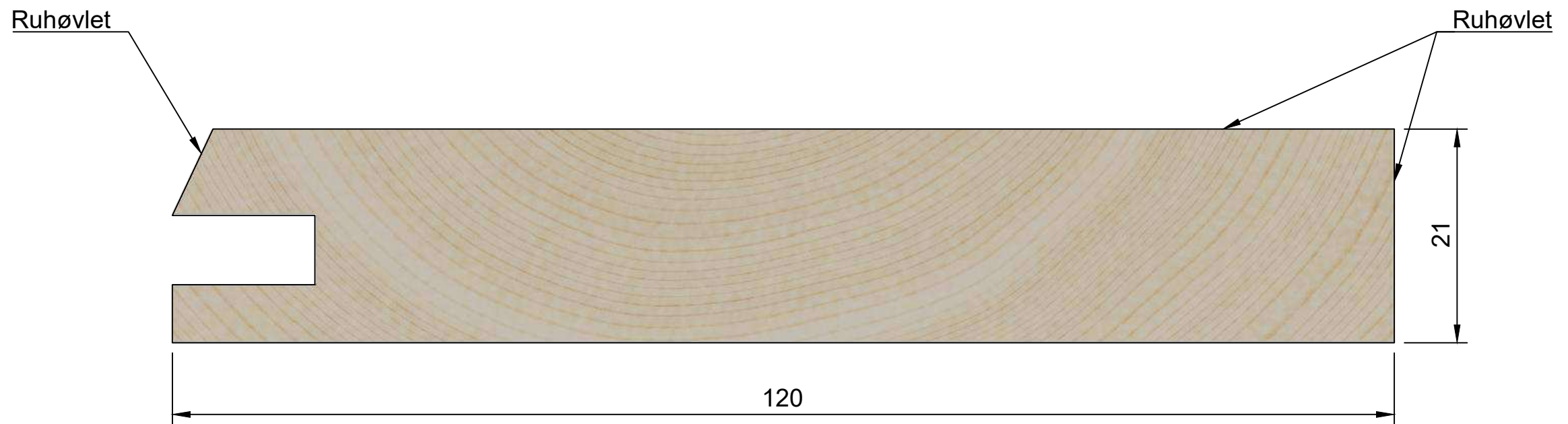

			
<b>Brandkrav:</b> K1 10 D-s2,d0 opsat på substrat A2-s1,d0 min. densitet 10kg/m3 (Se iøvrigt DoP).		<b>Titel:</b> SW06 Overstern 21x120mm, Salg	
<b>Tegner:</b>	<b>Dato</b> 06-11-2020	<b>Godkendt af:</b>	<b>Godkendt dato:</b>
<b>Rev.</b>	<b>Rev. dato</b>	<b>Note:</b> Alle mål er i mm. Tegningen er ikke målfast	<b>Sheet</b> 1/1

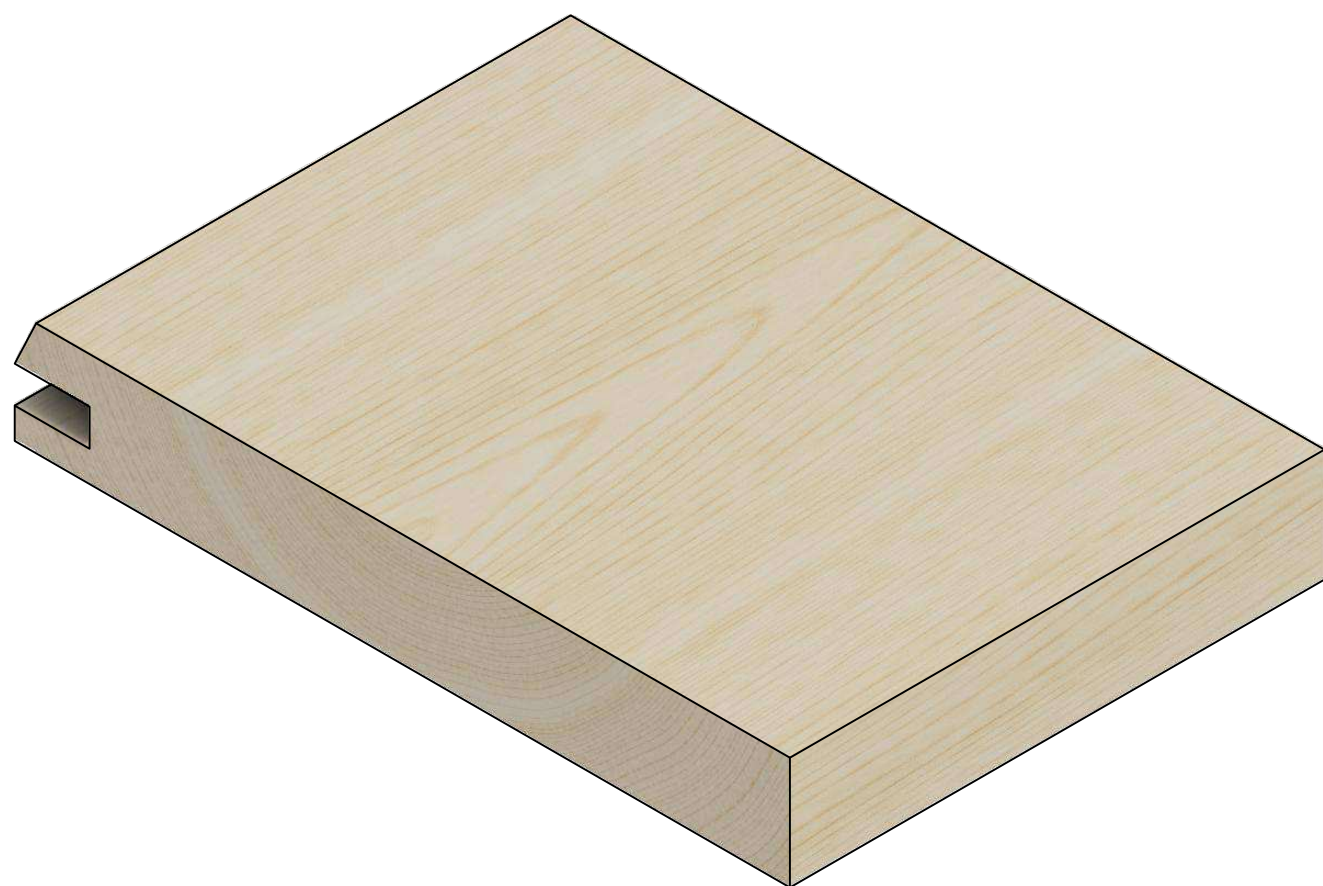
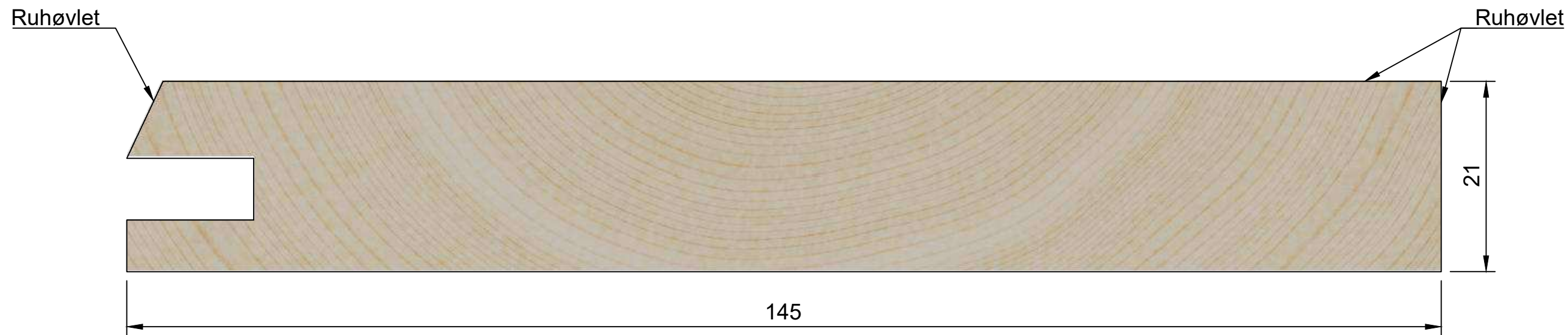

<b>Brandkrav:</b> K1 10 D-s2,d0 opsat på substrat A2-s1,d0 min. densitet 10kg/m3 (Se iøvrigt DoP).		<b>Titel:</b> SW06 Overstern 21x145mm, Salg	
<b>Tegner:</b>	<b>Dato</b> 06-11-2020	<b>Godkendt af:</b>	<b>Godkendt dato:</b>
<b>Rev.</b>	<b>Rev. dato</b>	<b>Note:</b> Alle mål er i mm. Tegningen er ikke målfast	<b>Sheet</b> 1/1

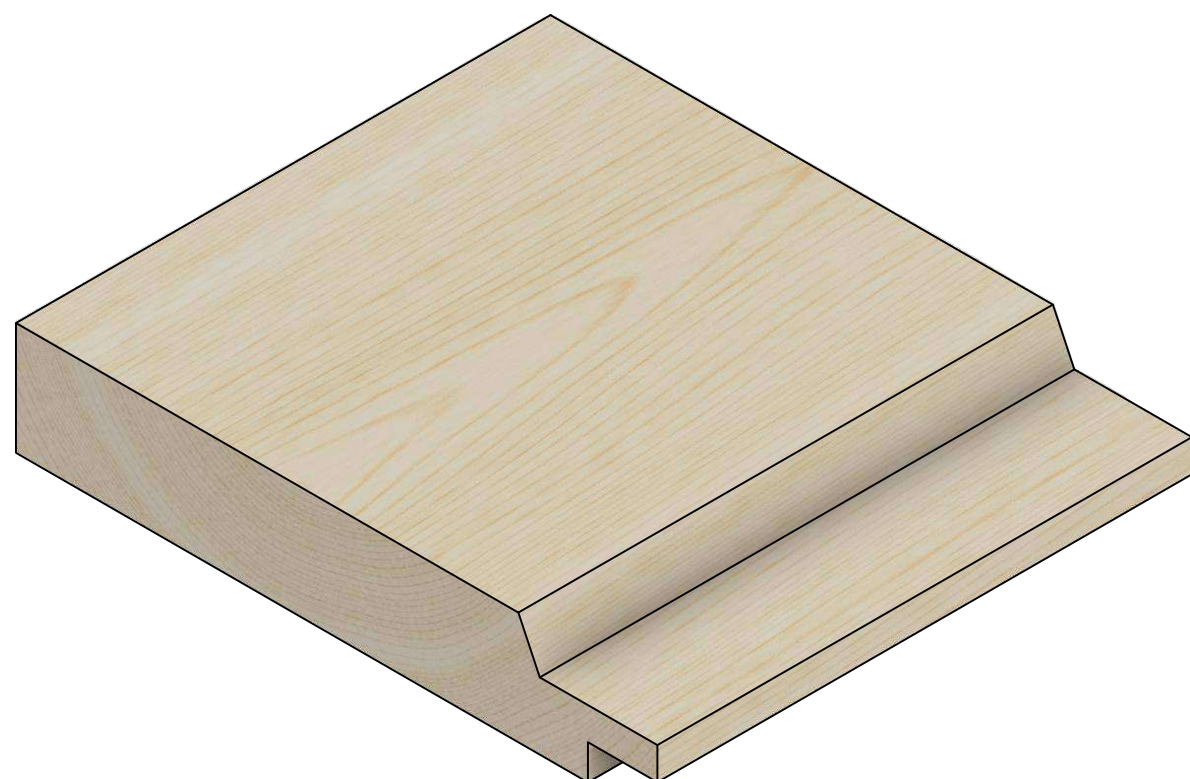
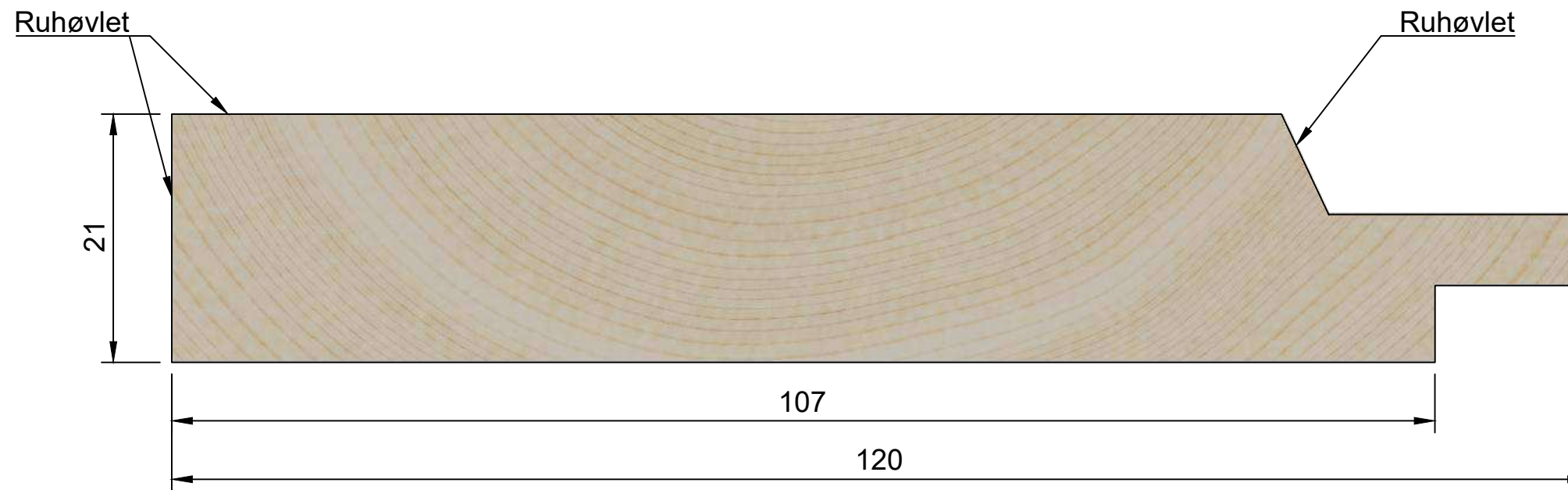

<b>Brandkrav:</b> K1 10 D-s2,d0 opsat på substrat A2-s1,d0 min. densitet 10kg/m3 (Se iøvrigt DoP).		<b>Titel:</b> SW06 Understern 21x120mm, Salg	
<b>Tegner:</b>	<b>Dato</b> 06-11-2020	<b>Godkendt af:</b>	<b>Godkendt dato:</b>
<b>Rev.</b>	<b>Rev. dato</b>	<b>Note:</b> Alle mål er i mm. Tegningen er ikke målfast	<b>Sheet</b> 1/1

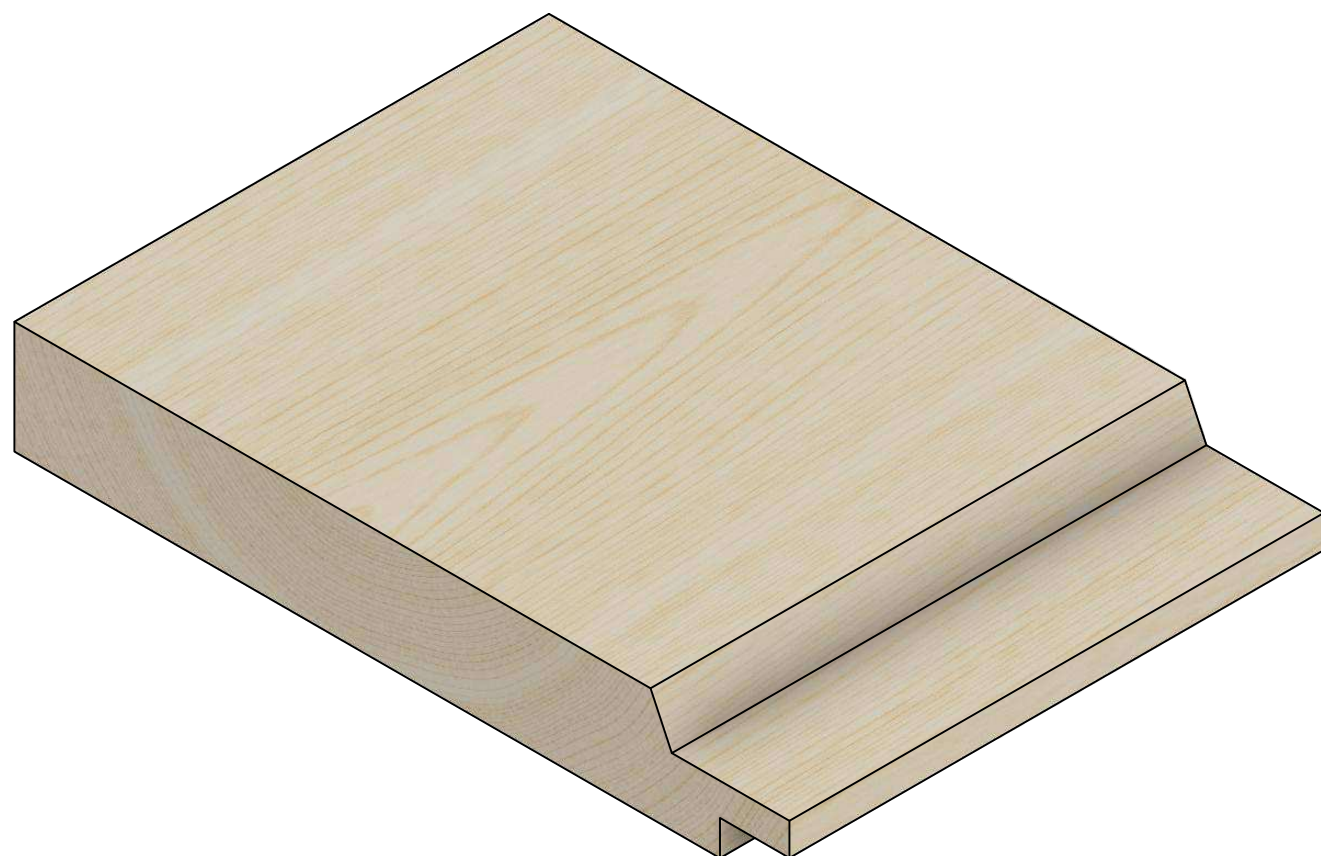
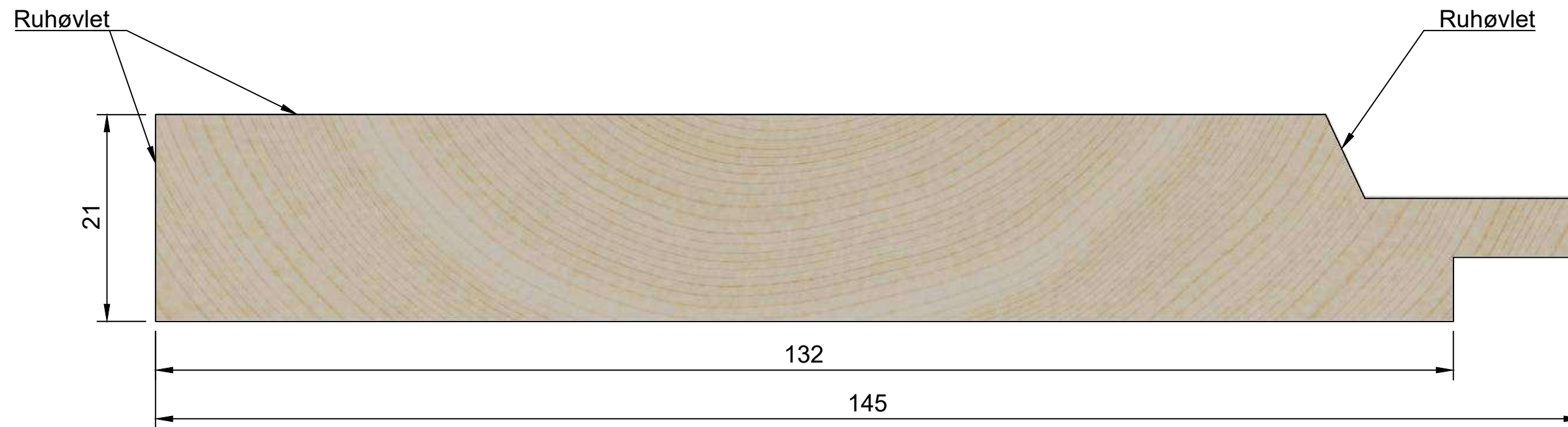

<b>Brandkrav:</b> K1 10 D-s2,d0 opsat på substrat A2-s1,d0 min. densitet 10kg/m3 (Se iøvrigt DoP).		<b>Titel:</b> SW06 Understern 21x145mm, Salg	
<b>Tegner:</b>	<b>Dato</b> 06-11-2020	<b>Godkendt af:</b>	<b>Godkendt dato:</b>
<b>Rev.</b>	<b>Rev. dato</b>	<b>Note:</b> Alle mål er i mm. Tegningen er ikke målfast	<b>Sheet</b> 1/1

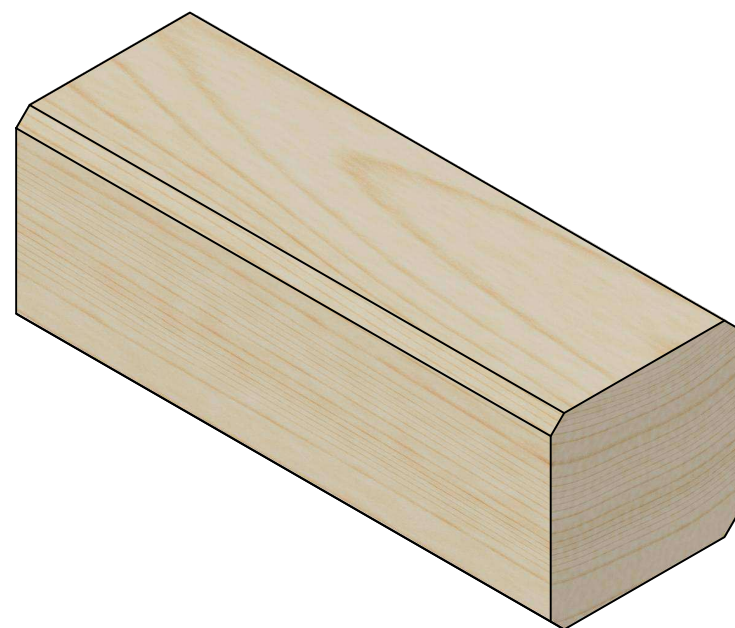

Ruhøvlet 4 sider

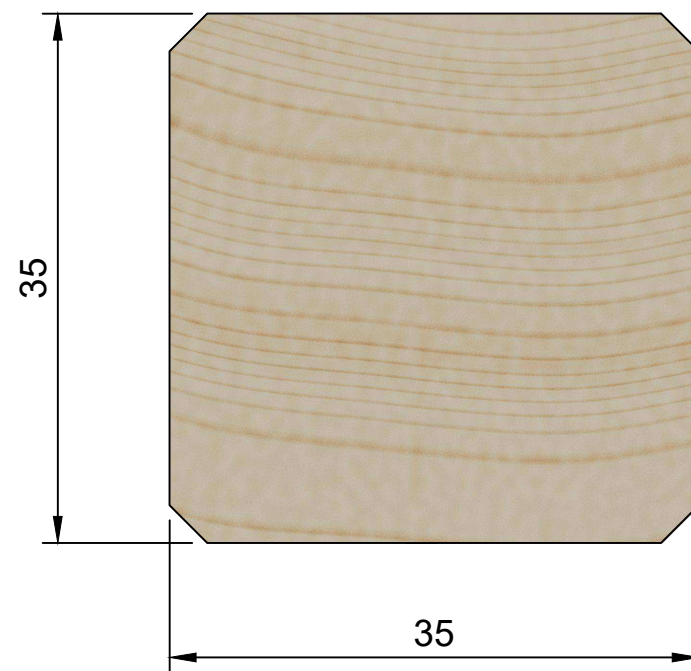

Brandkrav: D-s2,d0 (Se iverigt DoP).		Titel: SW08 Stolper 35x35mm, Salg	
Tegner:	Dato 06-11-2020	Godkendt af:	Godkendt dato:
Rev.	Rev. dato	Note: Alle mål er i mm. Tegningen er ikke målfast	Sheet 1/1

Ruhøvlet 4 sider

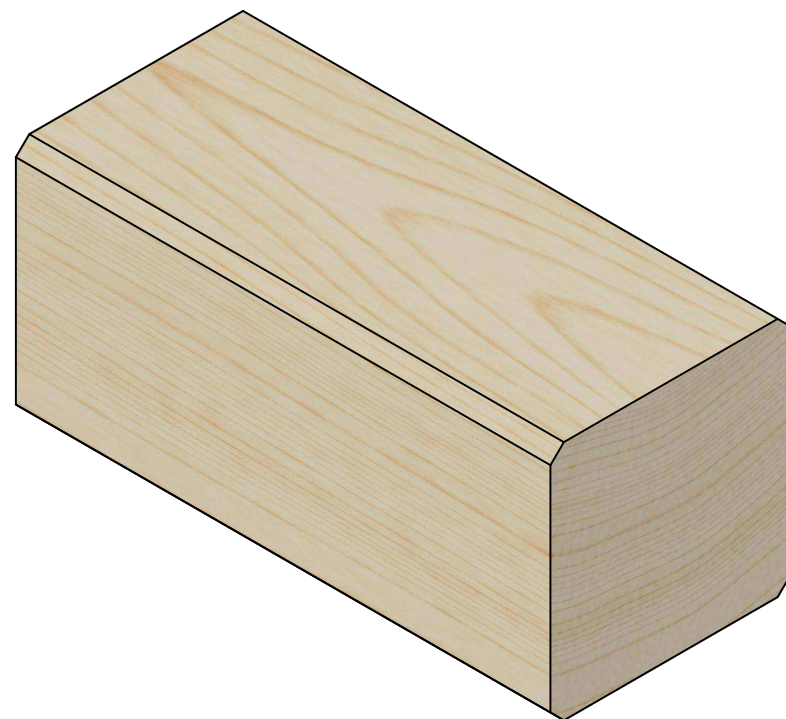
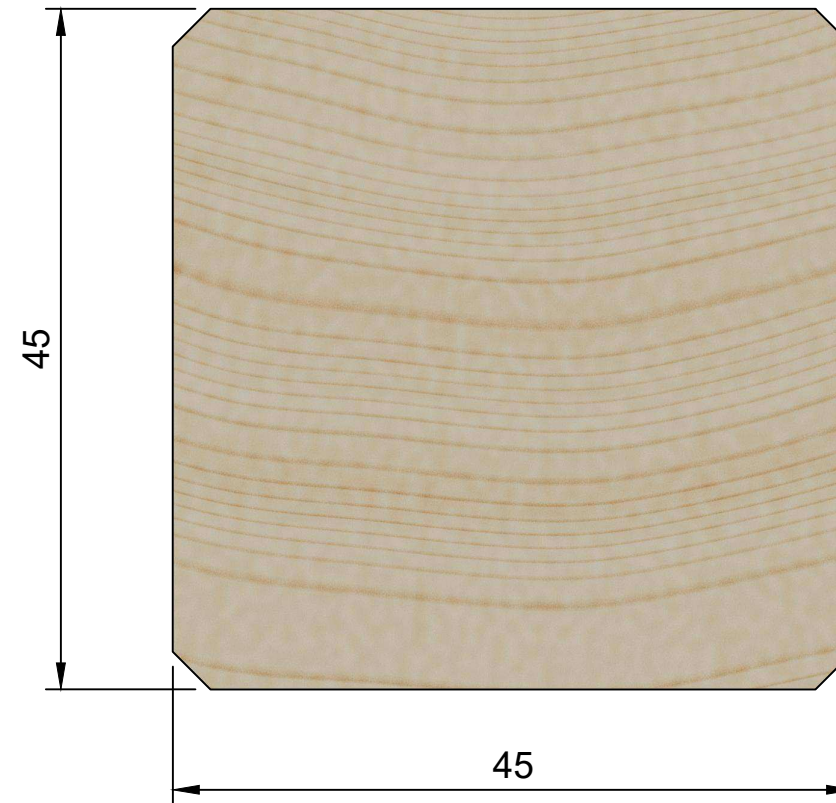

<b>Superwood<sup>®</sup></b>			
Brandkrav: D-s2,d0 (Se iøvrigt DoP).		Titel: SW08 Stolper 45x45mm, Salg	
Tegner:	Dato 06-11-2020	Godkendt af:	Godkendt dato:
Rev.	Rev. dato	Note: Alle mål er i mm. Tegningen er ikke målfast	Sheet 1/1



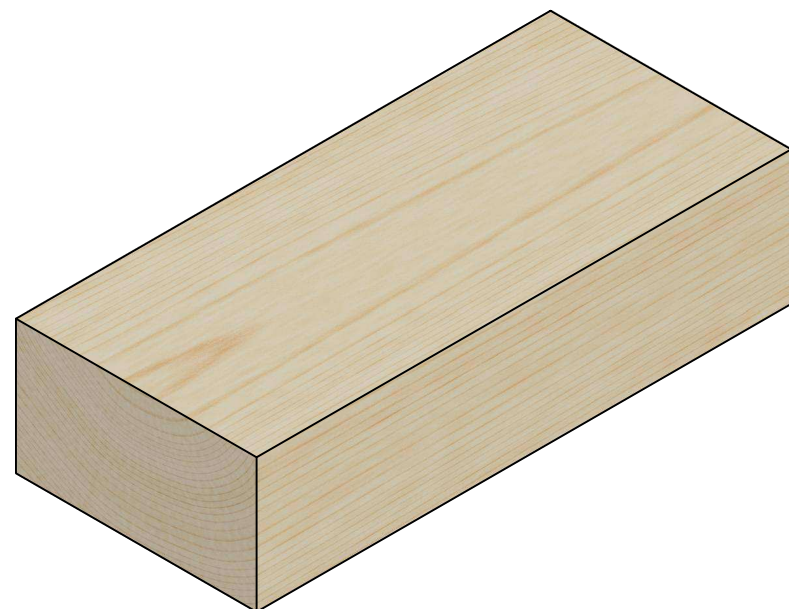
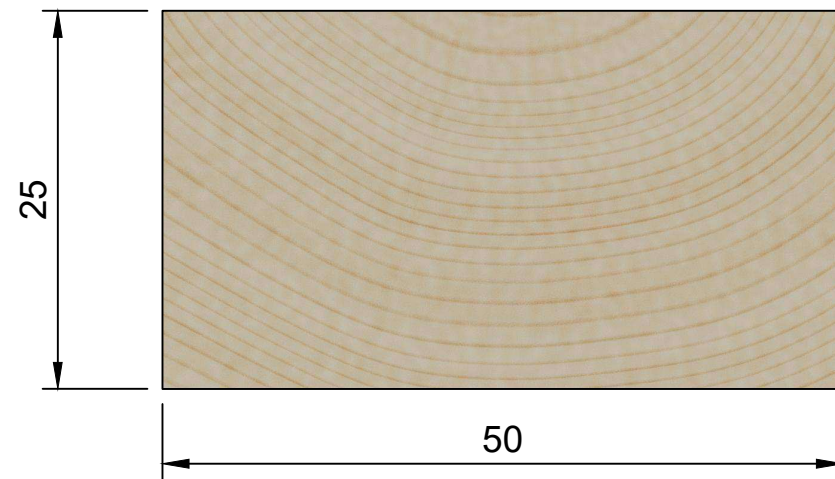

			
<b>Brandkrav:</b> D-s2,d0 (Se iøvrigt DoP).		<b>Titel:</b> SW09 Klemliste 25x50mm, Salg	
<b>Tegner:</b>	<b>Dato</b> 11-11-2020	<b>Godkendt af:</b>	<b>Godkendt dato:</b>
<b>Rev.</b>	<b>Rev. dato</b>	<b>Note:</b> Alle mål er i mm. Tegningen er ikke målfast	<b>Sheet</b> 1/1

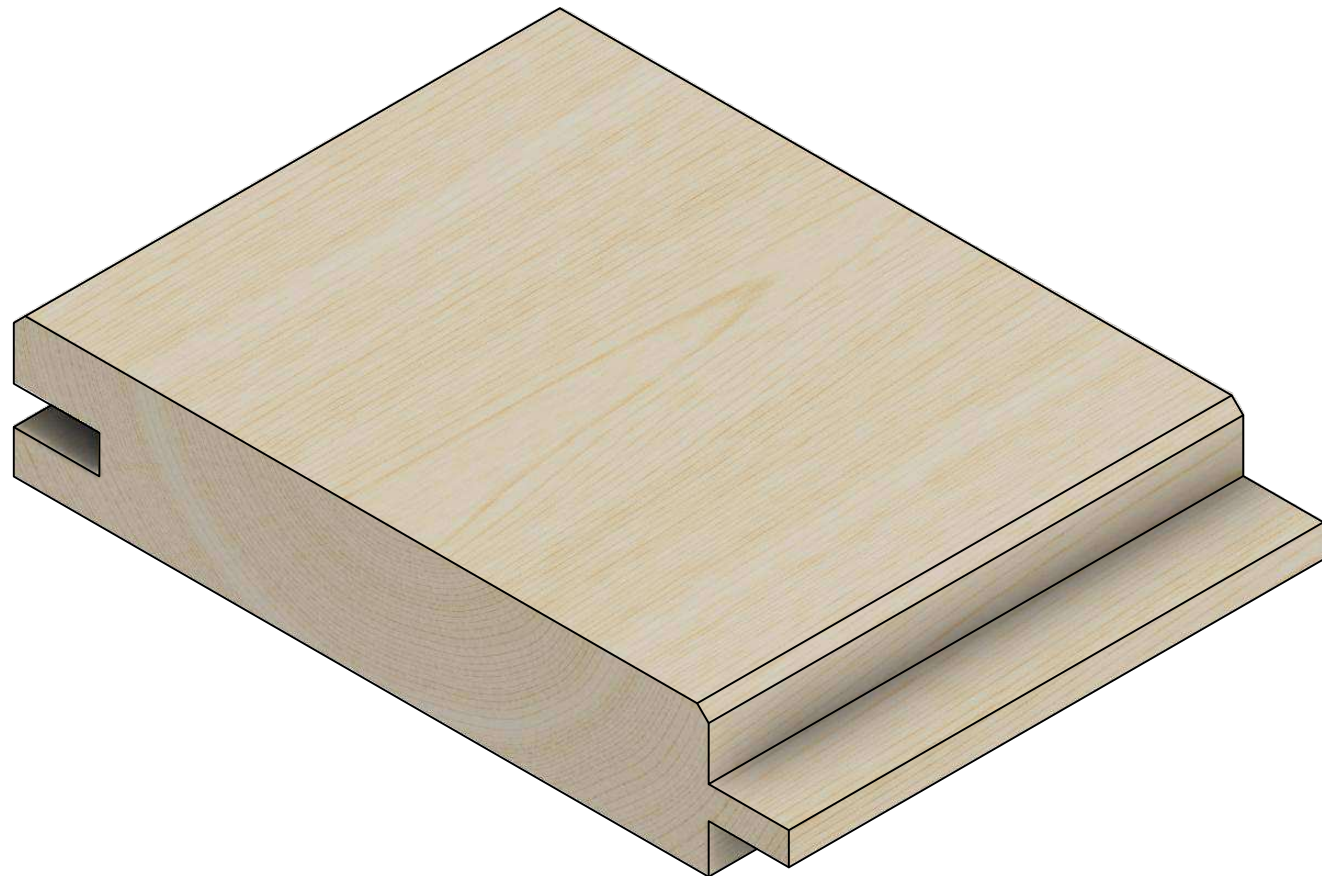
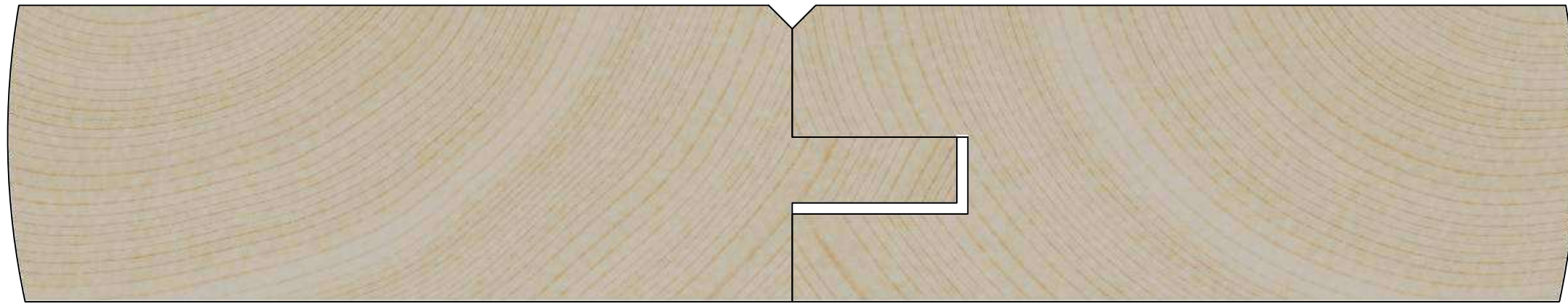
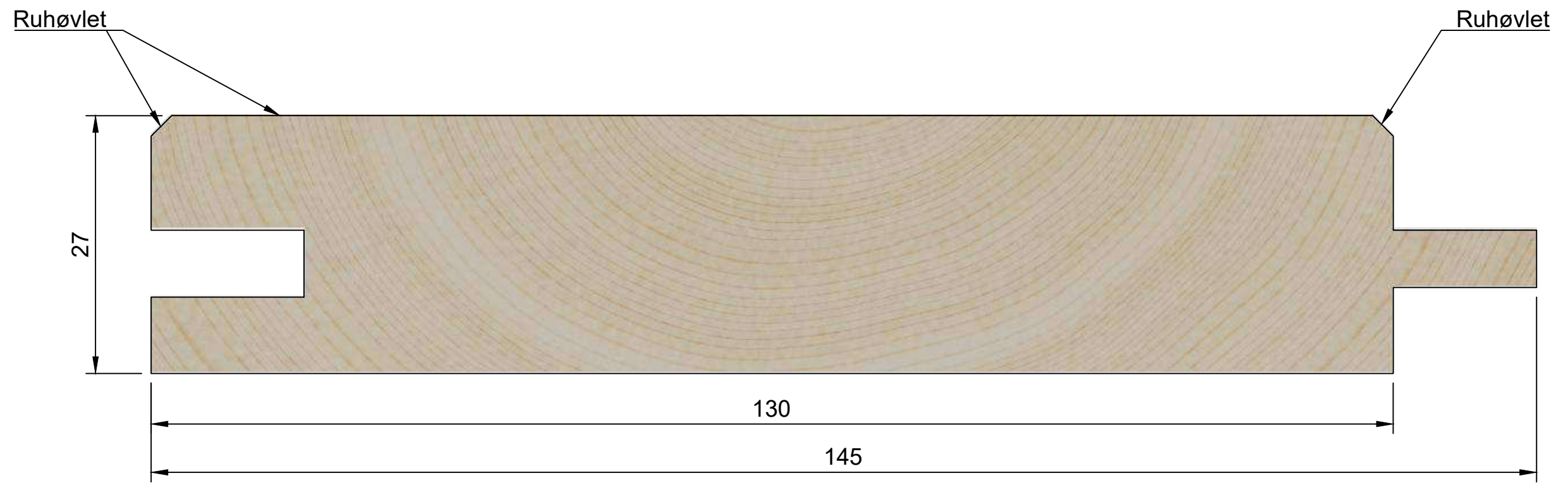

<b>Brandkrav:</b> K1 10 D-s2,d0 opsat på substrat A2-s1,d0 min. densitet 10kg/m3 (Se iøvrigt DoP).		<b>Titel:</b> SW11 Skagens-profil 27x145mm, Salg	
<b>Tegner:</b>	<b>Dato</b> 06-11-2020	<b>Godkendt af:</b>	<b>Godkendt dato:</b>
<b>Rev.</b>	<b>Rev. dato</b>	<b>Note:</b> Alle mål er i mm. Tegningen er ikke målfast	<b>Sheet</b> 1/1

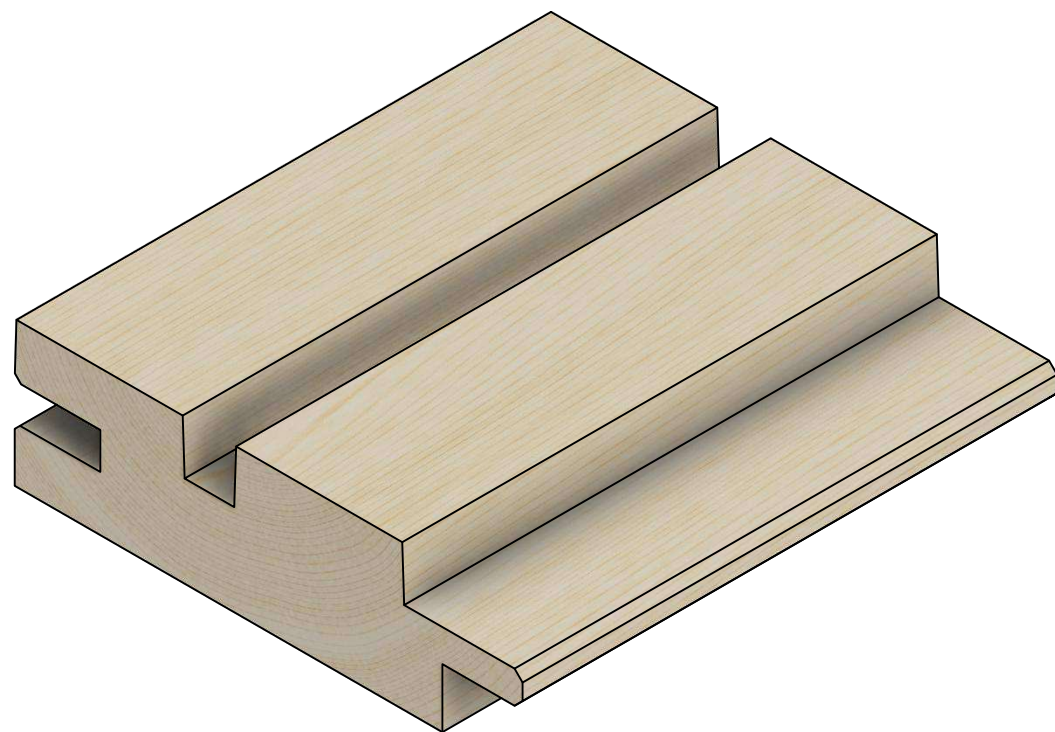
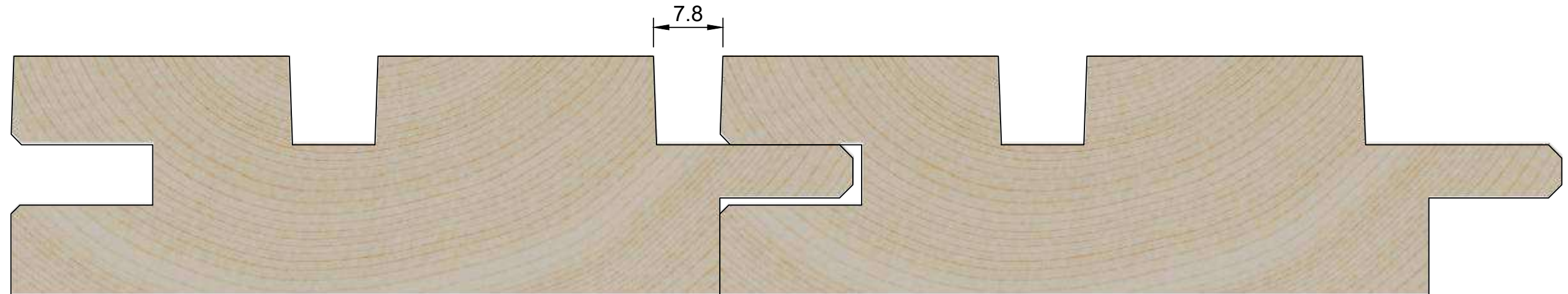
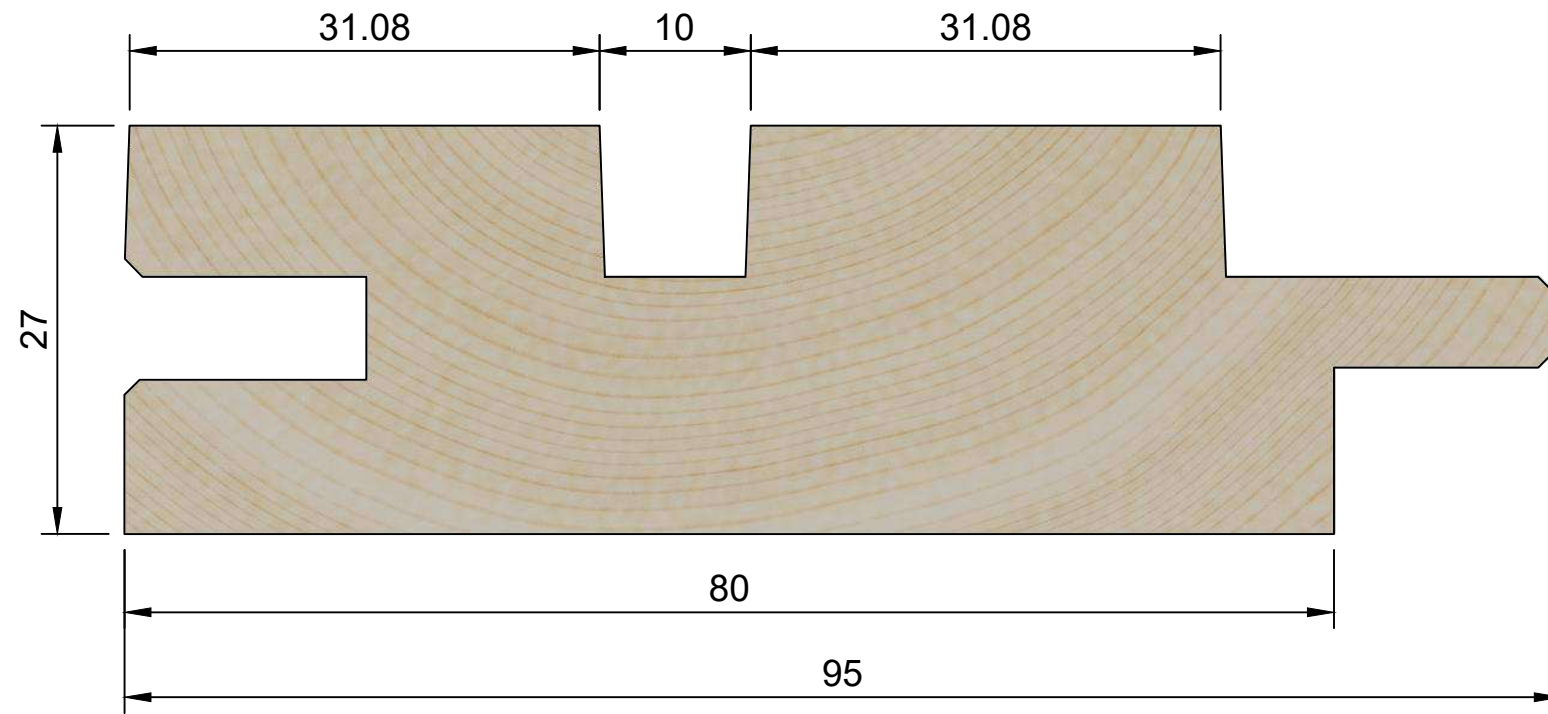

<b>Brandkrav:</b> K1 10 D-s2,d0 opsat på substrat min. 300 kg/m3		<b>Titel:</b> SW12 AART Small 27x95mm, Salg	
<b>Tegner:</b> Lars Antonsen	<b>Dato</b> 03-09-2021	<b>Godkendt af:</b> PK	<b>Godkendt dato:</b> 18-01-2022
<b>Rev.</b>	<b>Rev. dato</b>	<b>Note:</b> Alle mål er i mm. Tegningen er ikke målfast.	<b>Sheet</b> 1/1

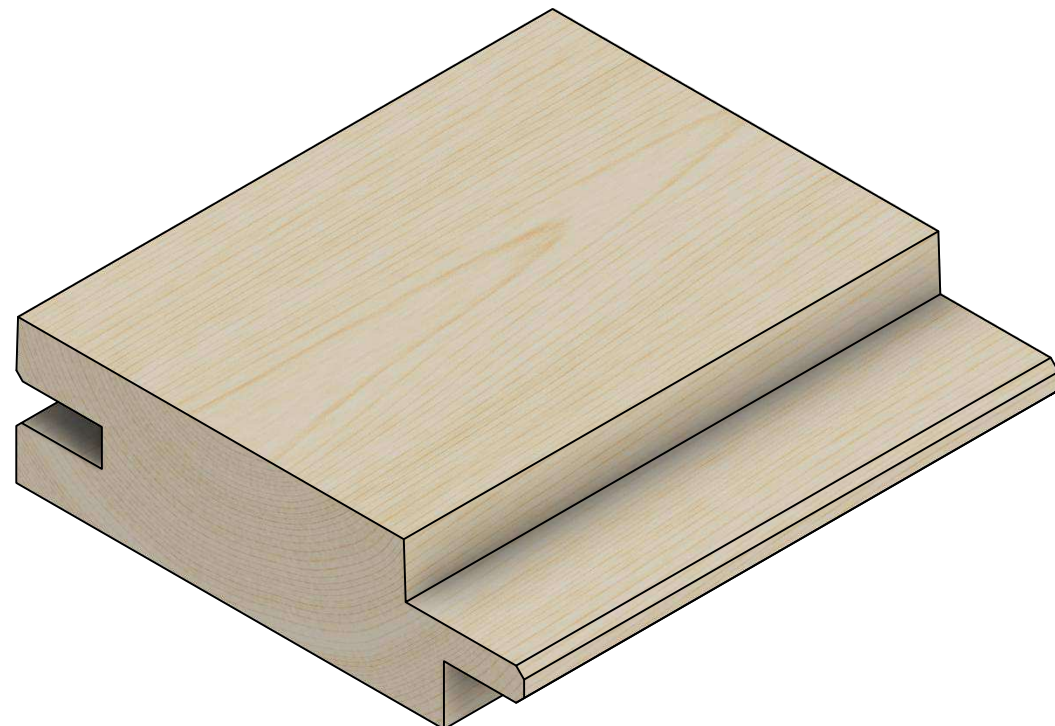
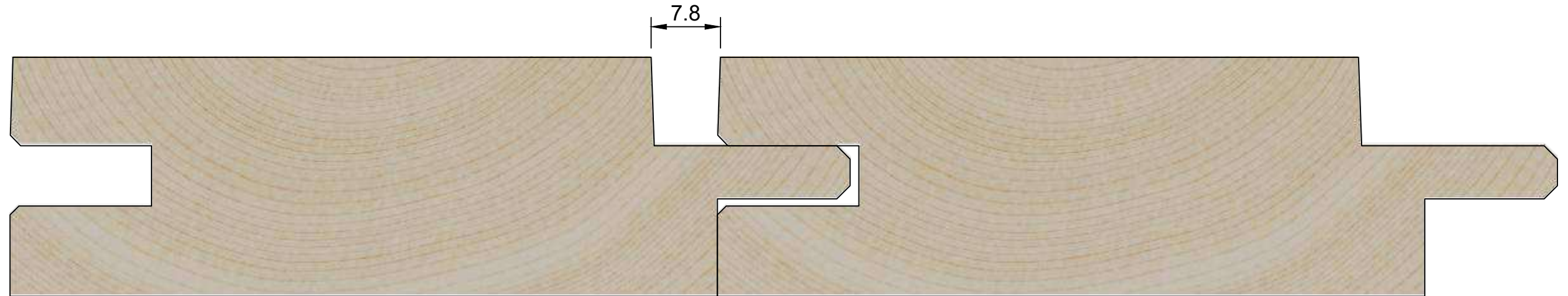
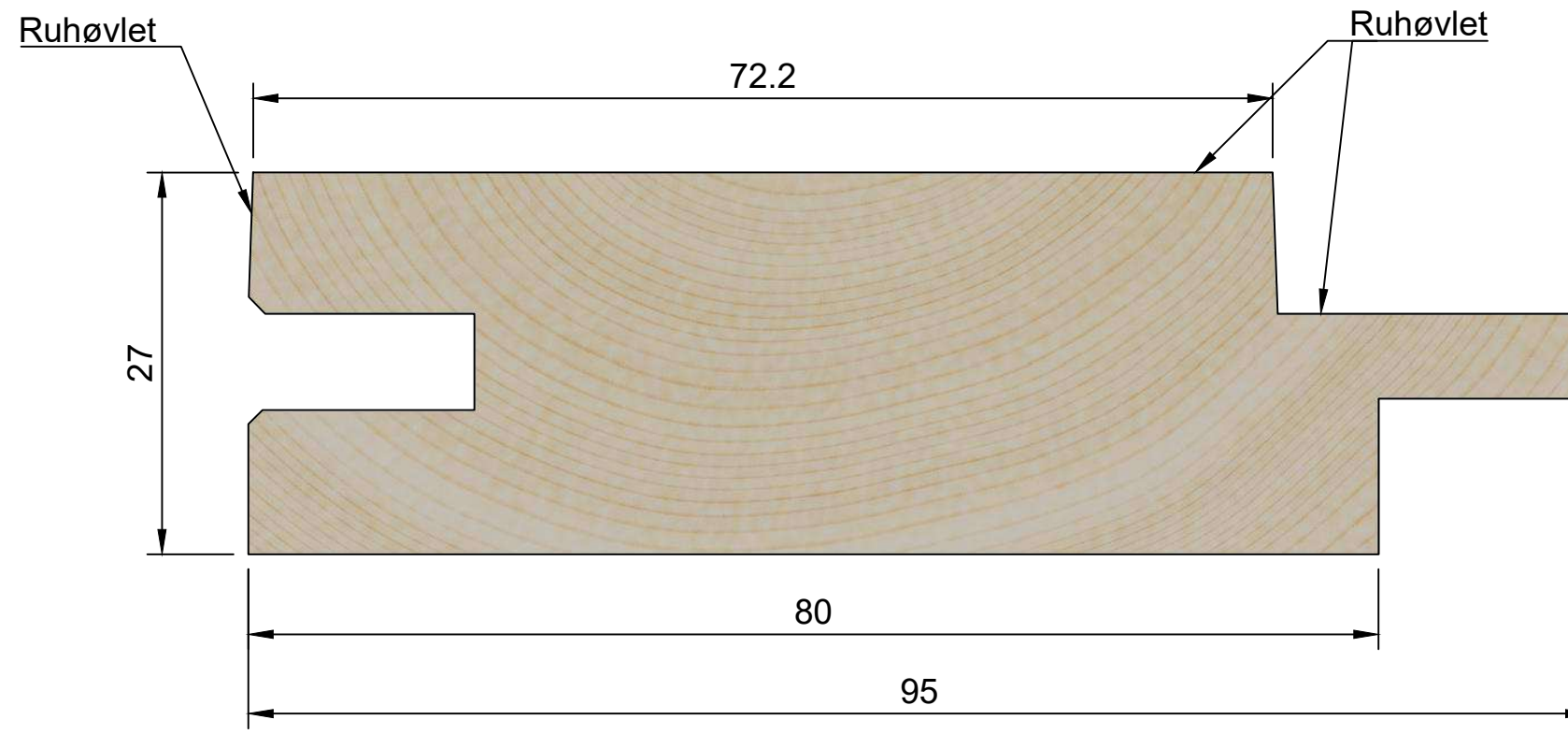

<b>Brandkrav:</b> K1 10 D-s2,d0 opsat på substrat A2-s1,d0 min. densitet 10kg/m3 (Se iøvrigt DoP).		<b>Titel:</b> SW12 Medium 27x95mm, Salg	
<b>Tegner:</b> LA	<b>Dato</b> 15-09-2021	<b>Godkendt af:</b> PK	<b>Godkendt dato:</b> 16-09-2021
<b>Rev.</b> A	<b>Rev. dato</b> 06-12-2021	<b>Note:</b> Alle mål er i mm. Tegningen er ikke målfast	<b>Sheet</b> 1/1

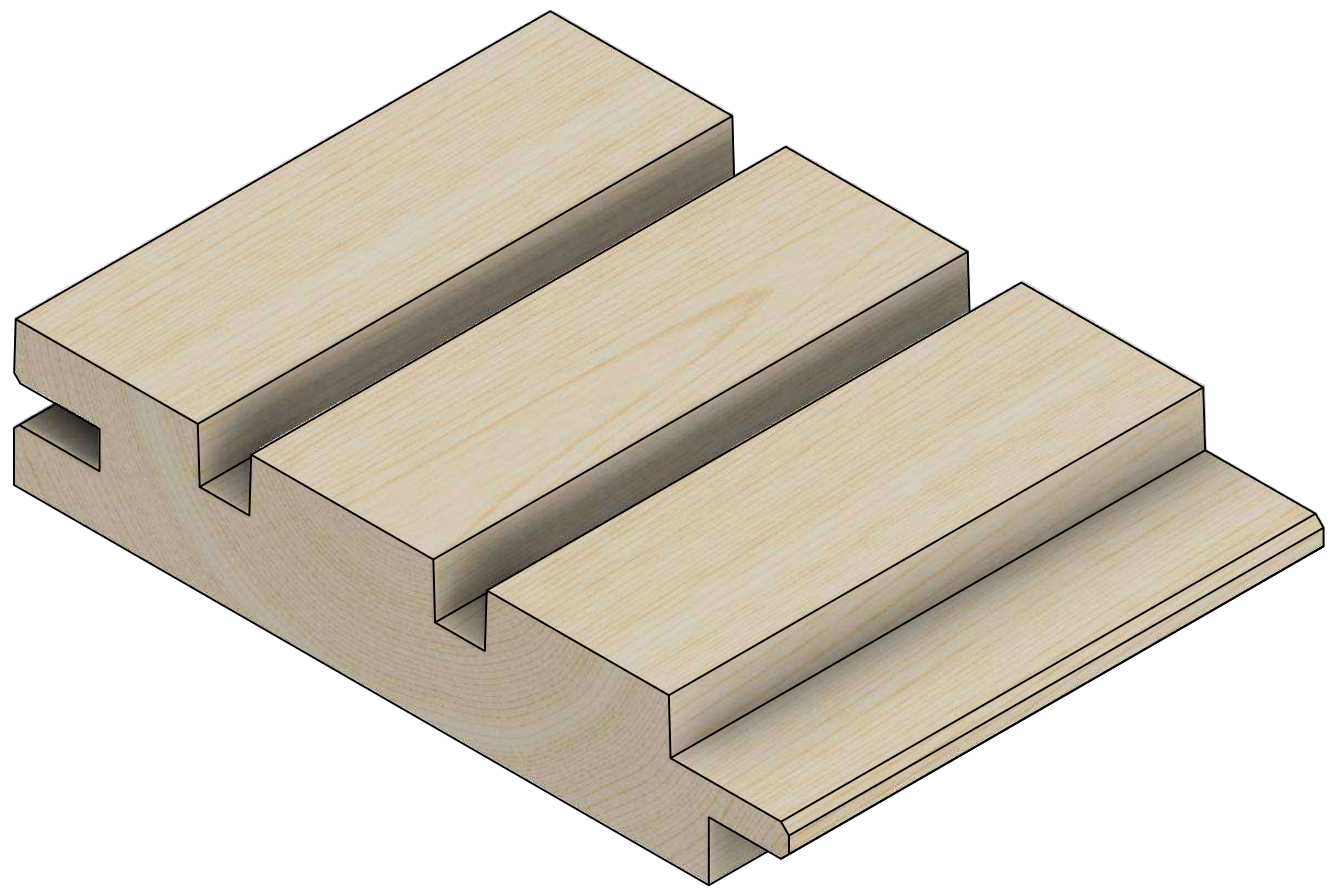
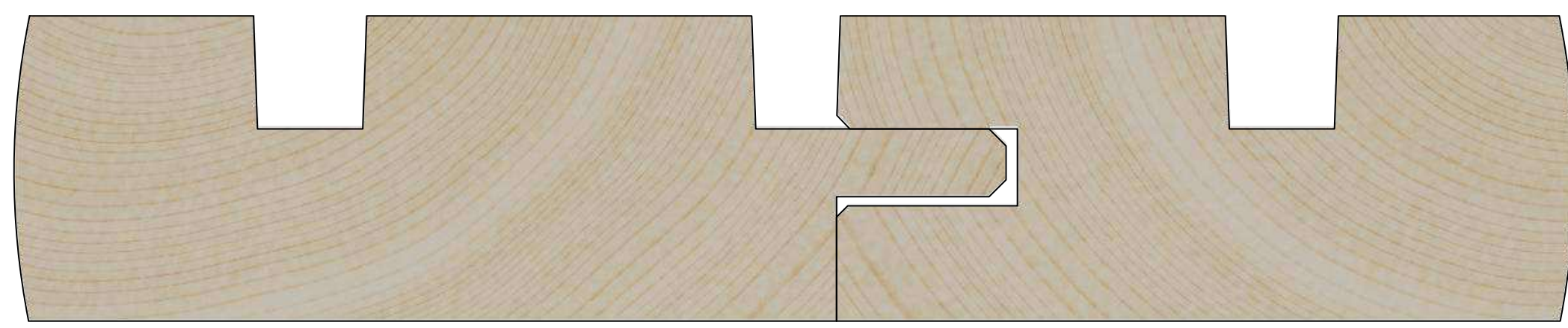
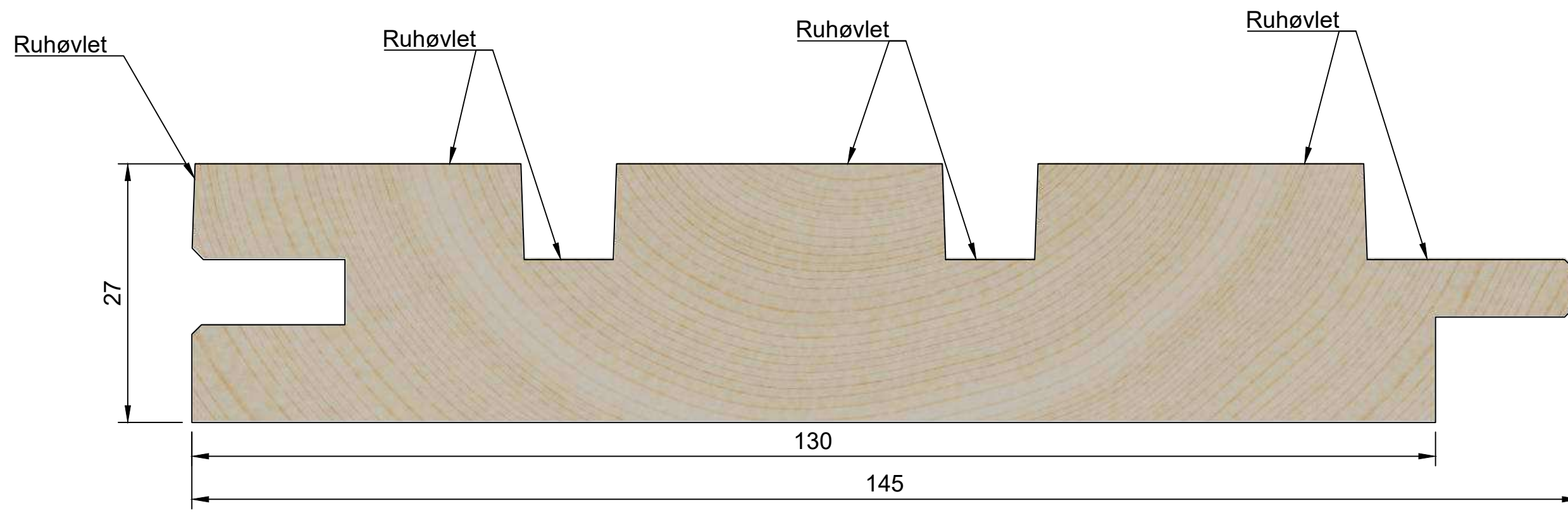

			
<b>Brandkrav:</b> K1 10 D-s2,d0 opsat på substrat A2-s1,d0 min. densitet 10kg/m3 (Se iverigt DoP).		<b>Titel:</b> SW12 AART Small 27x145mm, Salg	
<b>Tegner:</b>	<b>Dato</b> 09-11-2020	<b>Godkendt af:</b>	<b>Godkendt dato:</b>
<b>Rev.</b>	<b>Rev. dato</b>	<b>Note:</b> Alle mål er i mm. Tegningen er ikke målfast	<b>Sheet</b> 1/1

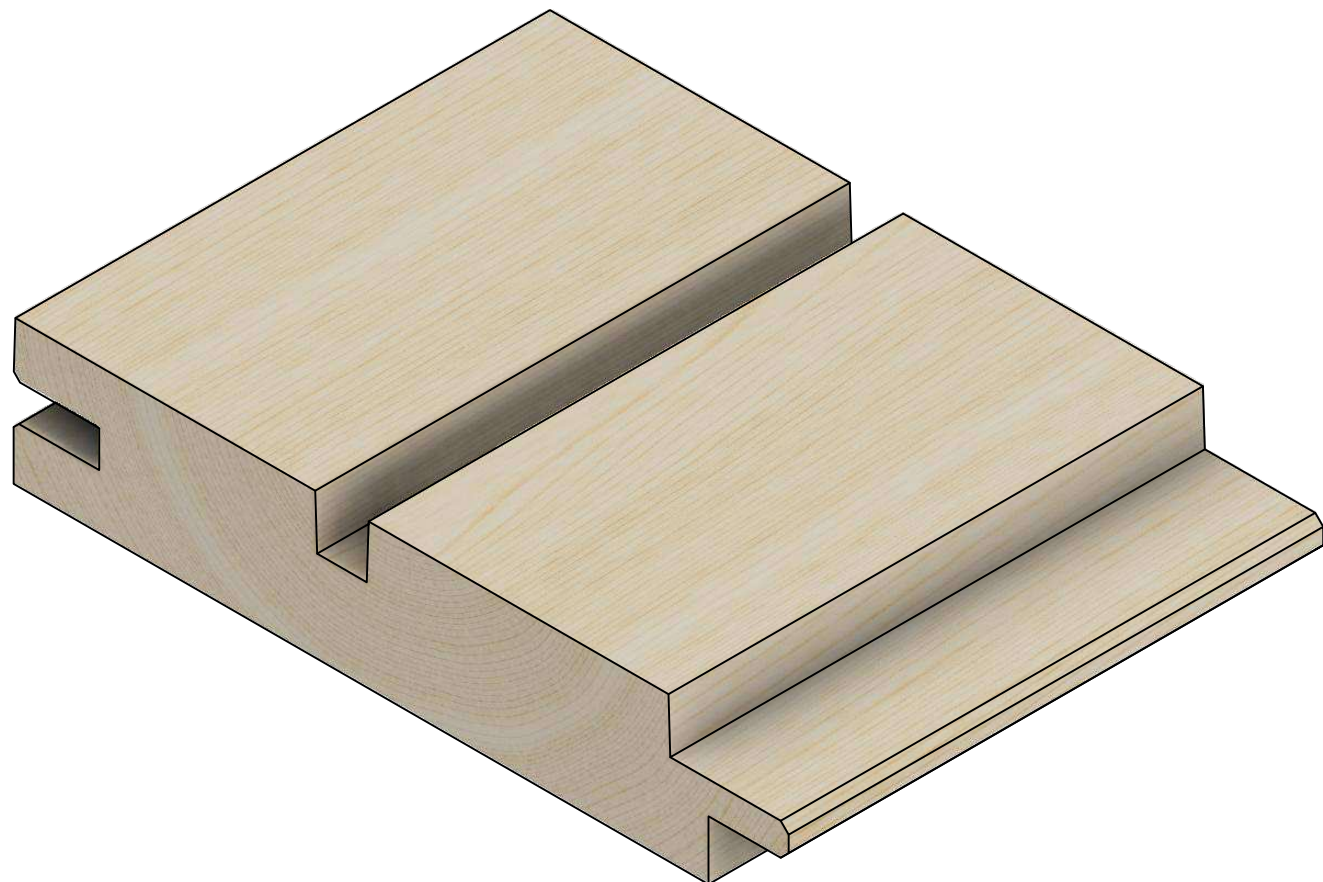
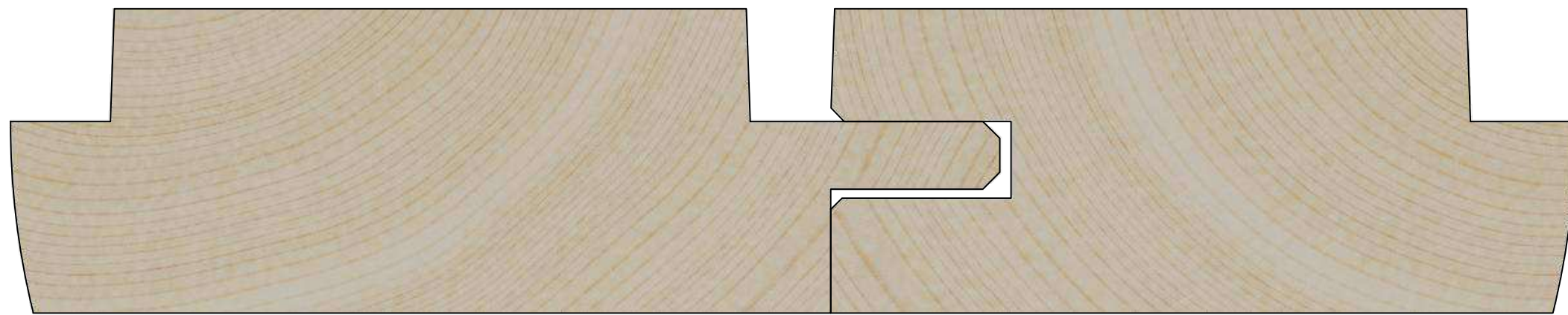
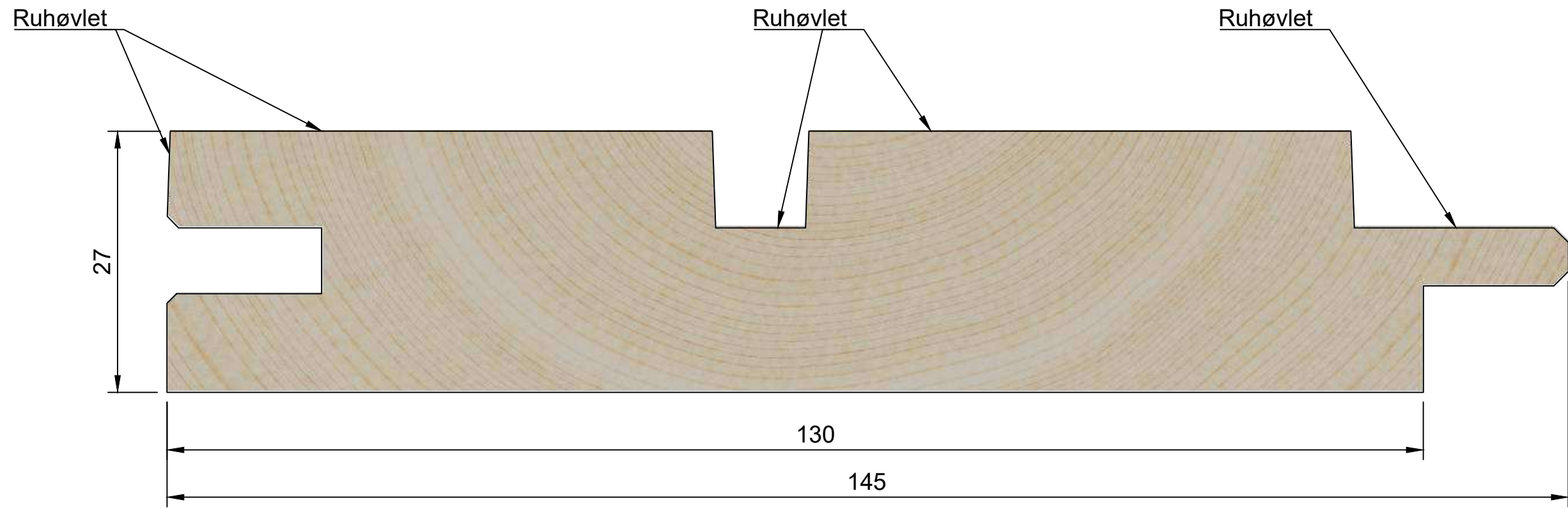

<b>Brandkrav:</b> K1 10 D-s2,d0 opsat på substrat A2-s1,d0 min. densitet 10kg/m3 (Se iøvrigt DoP).		<b>Titel:</b> SW12 AART Medium 27x145mm, Salg	
<b>Tegner:</b>	<b>Dato</b> 09-11-2020	<b>Godkendt af:</b>	<b>Godkendt dato:</b>
<b>Rev.</b>	<b>Rev. dato</b>	<b>Note:</b> Alle mål er i mm. Tegnigen er ikke målfast	<b>Sheet</b> 1/1

Ruhøvlet

Ruhøvlet

27

130

145

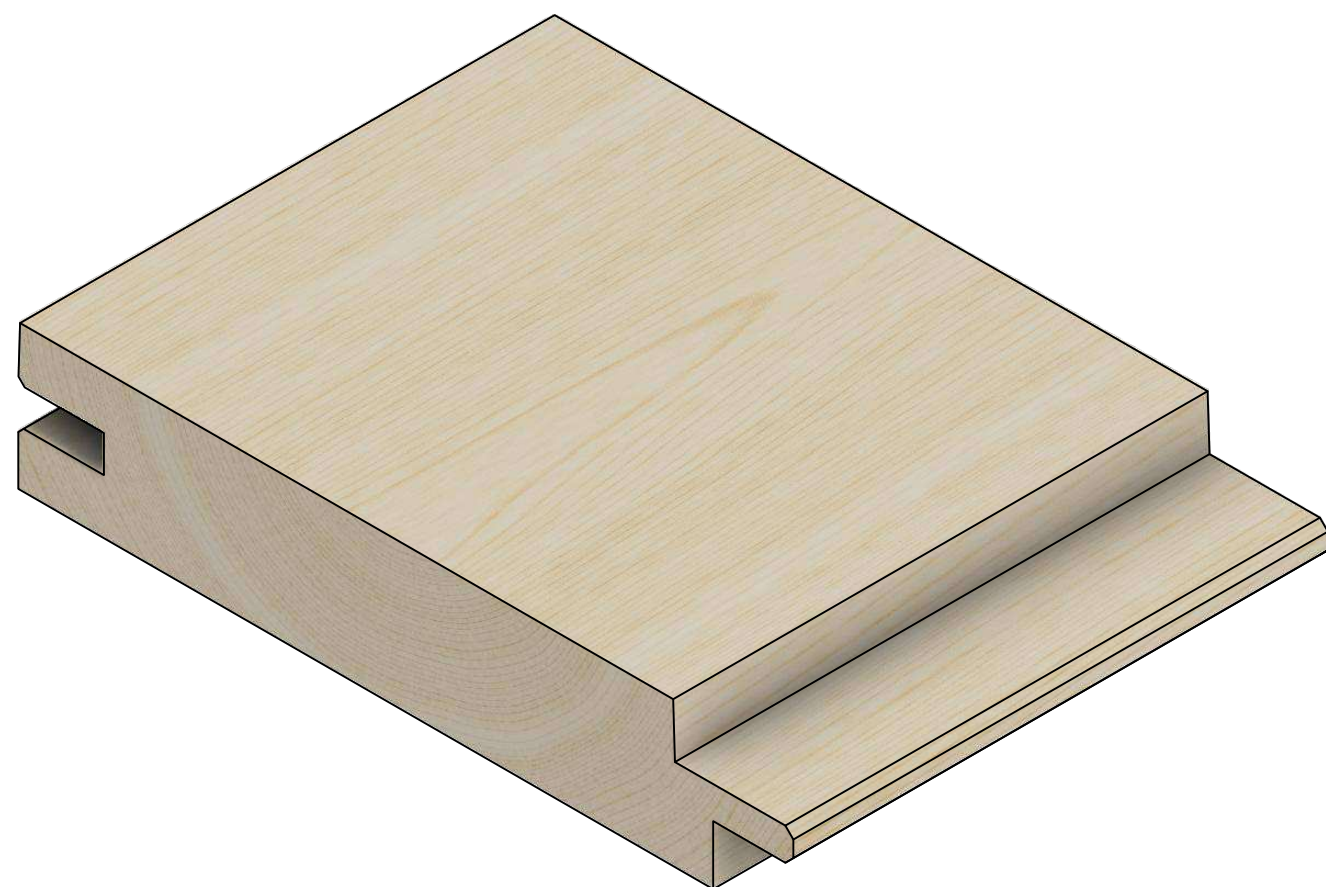

<b>Brandkrav:</b> K1 10 D-s2,d0 opsat på substrat A2-s1,d0 min. densitet 10kg/m3 (Se iøvrigt DoP).		<b>Titel:</b> SW12 AART Large 27x145mm, Salg	
<b>Tegner:</b>	<b>Dato</b> 09-11-2020	<b>Godkendt af:</b>	<b>Godkendt dato:</b>
<b>Rev.</b>	<b>Rev. dato</b>	<b>Note:</b> Alle mål er i mm. Tegningen er ikke målfast	<b>Sheet</b> 1/1

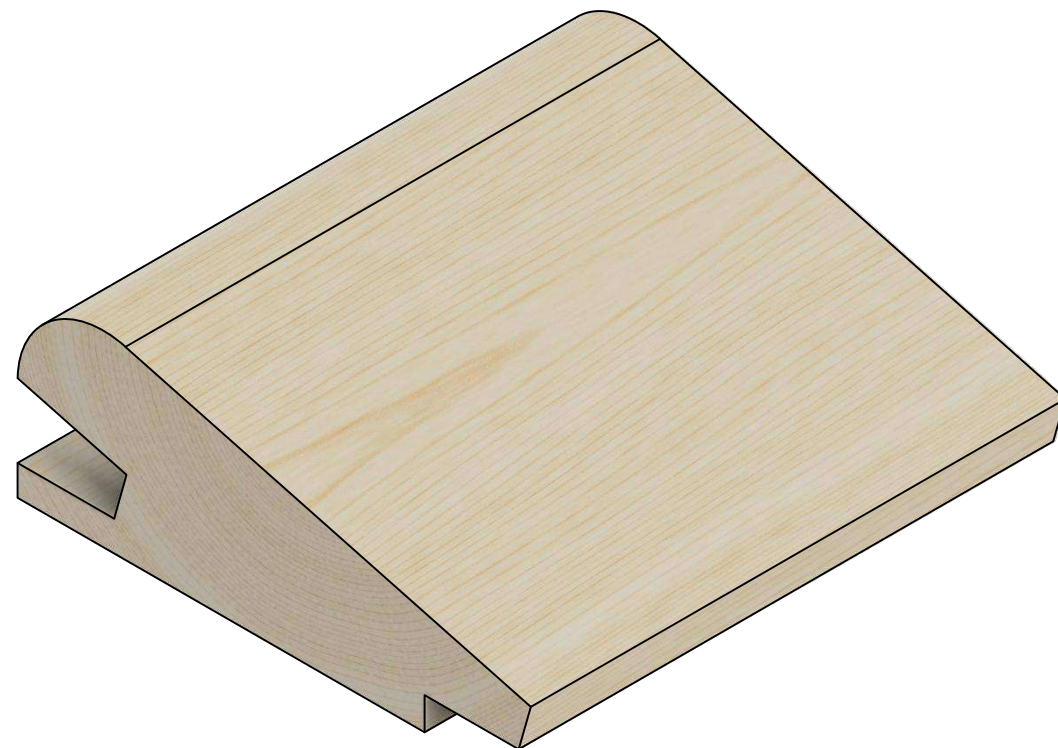
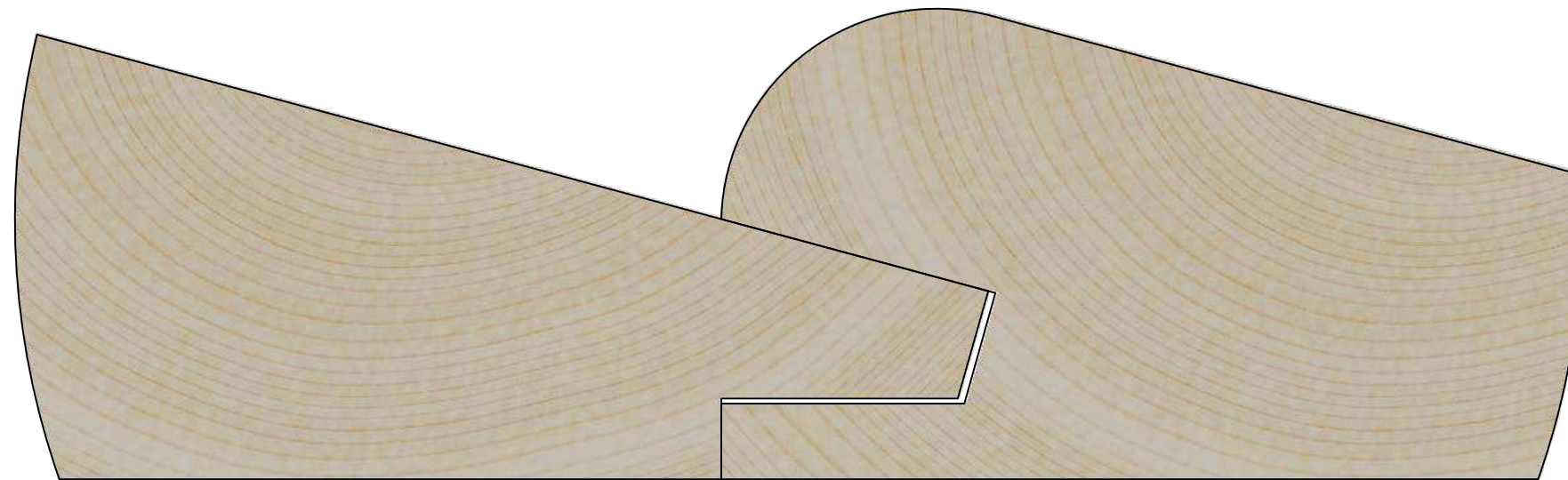
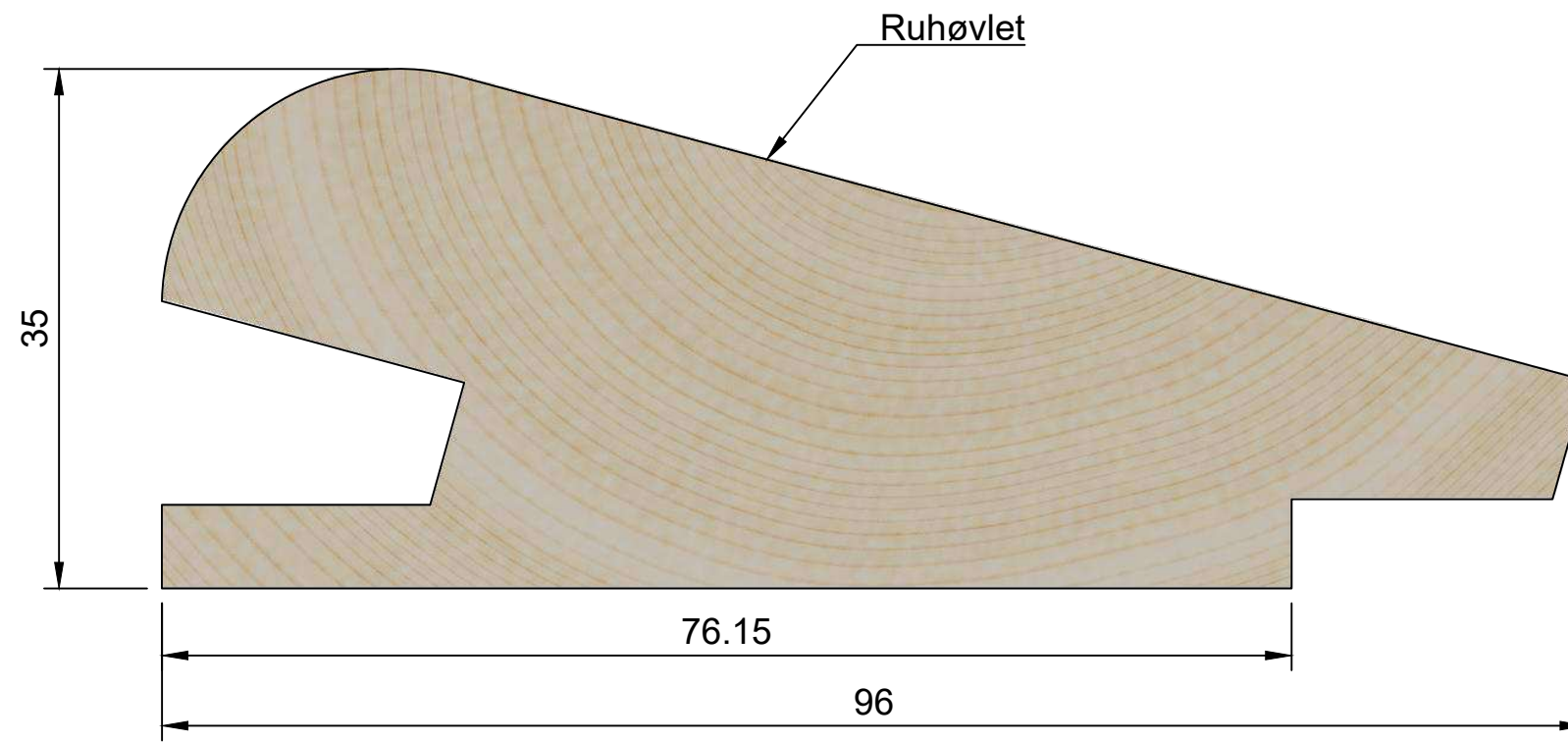

<b>Brandkrav:</b> K1 10 D-s2,d0 opsat på substrat A2-s1,d0 min. densitet 10kg/m3 (Se iverigt DoP).		<b>Titel:</b> SW13 Bølge-profil 35x96mm, Salg	
<b>Tegner:</b>	<b>Dato</b> 12-11-2020	<b>Godkendt af:</b>	<b>Godkendt dato:</b>
<b>Rev.</b>	<b>Rev. dato</b>	<b>Note:</b> Alle mål er i mm. Tegningen er ikke målfast	<b>Sheet</b> 1/1



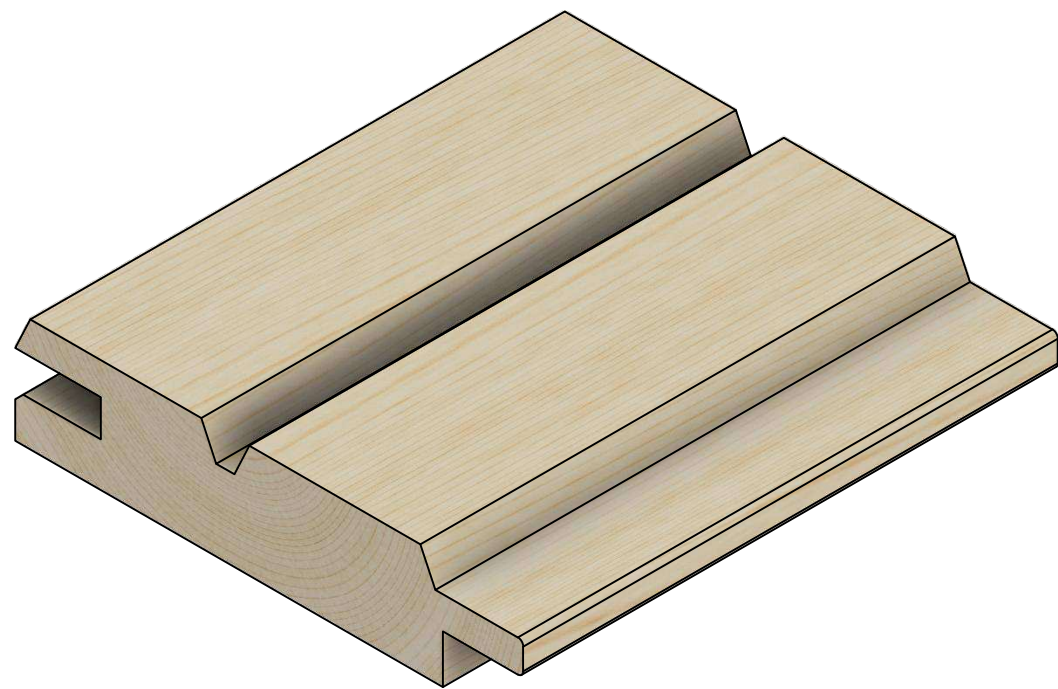
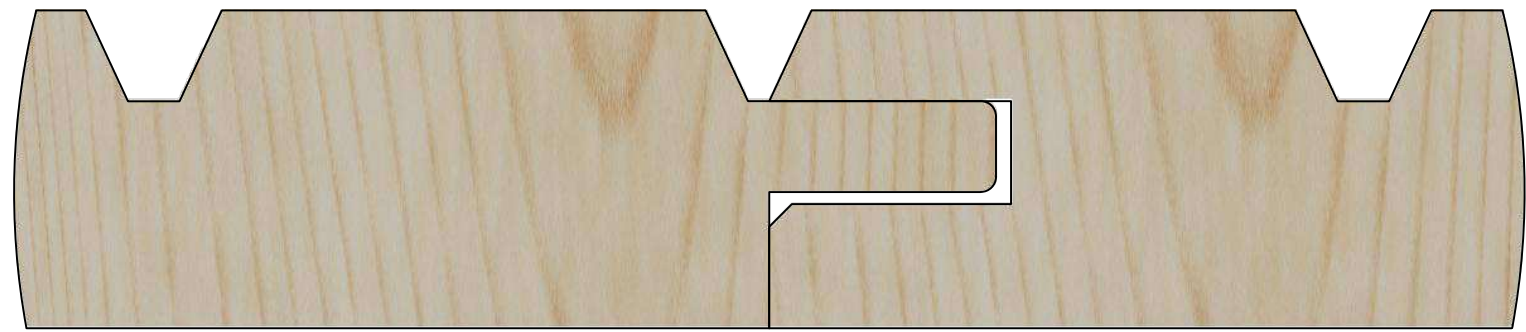
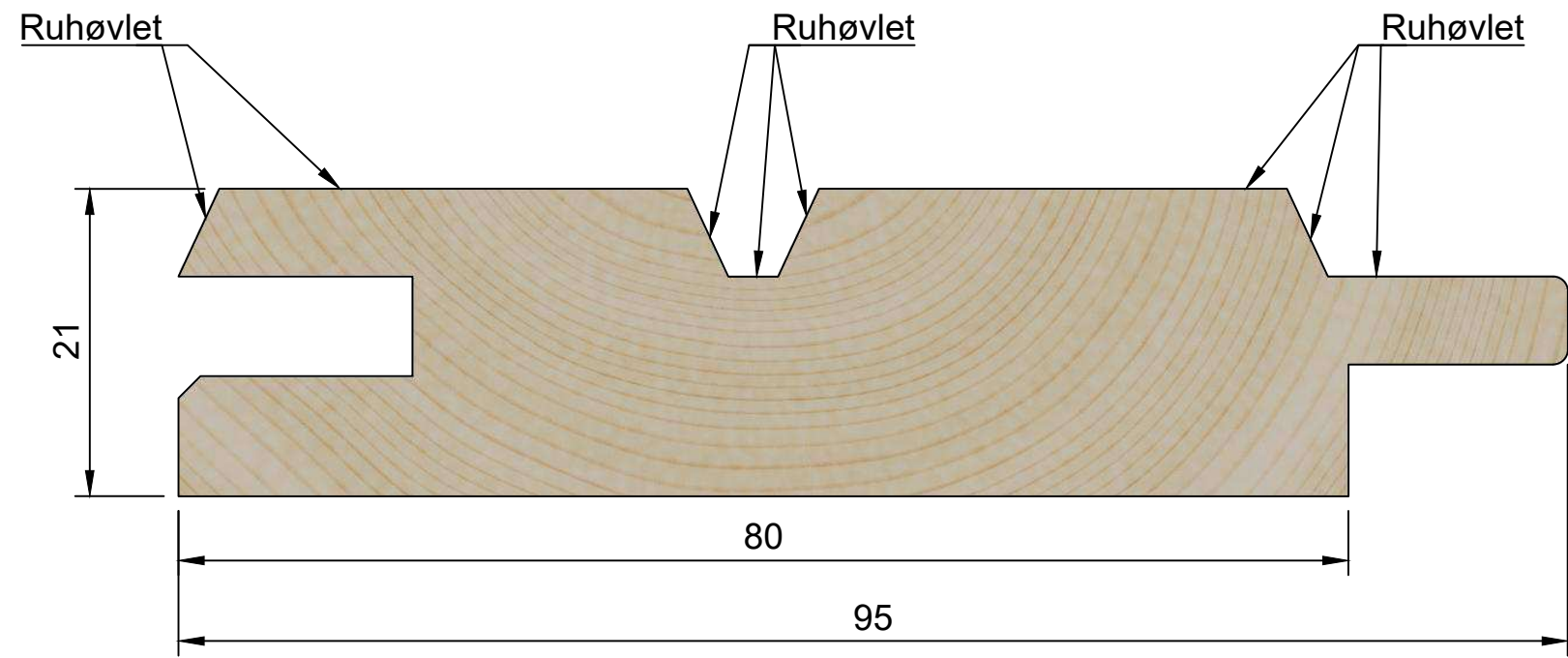

			
<b>Brandkrav:</b> K1 10 D-s2,d0 opsat på substrat A2-s1,d0 min. densitet 10kg/m3 (Se iverigt DoP).		<b>Titel:</b> SW14 AART Small 21x95mm, Salg	
<b>Tegner:</b>	<b>Dato</b> 17-11-2020	<b>Godkendt af:</b>	<b>Godkendt dato:</b>
<b>Rev.</b>	<b>Rev. dato</b>	<b>Note:</b> Alle mål er i mm. Tegningen er ikke målfast	<b>Sheet</b> 1/1

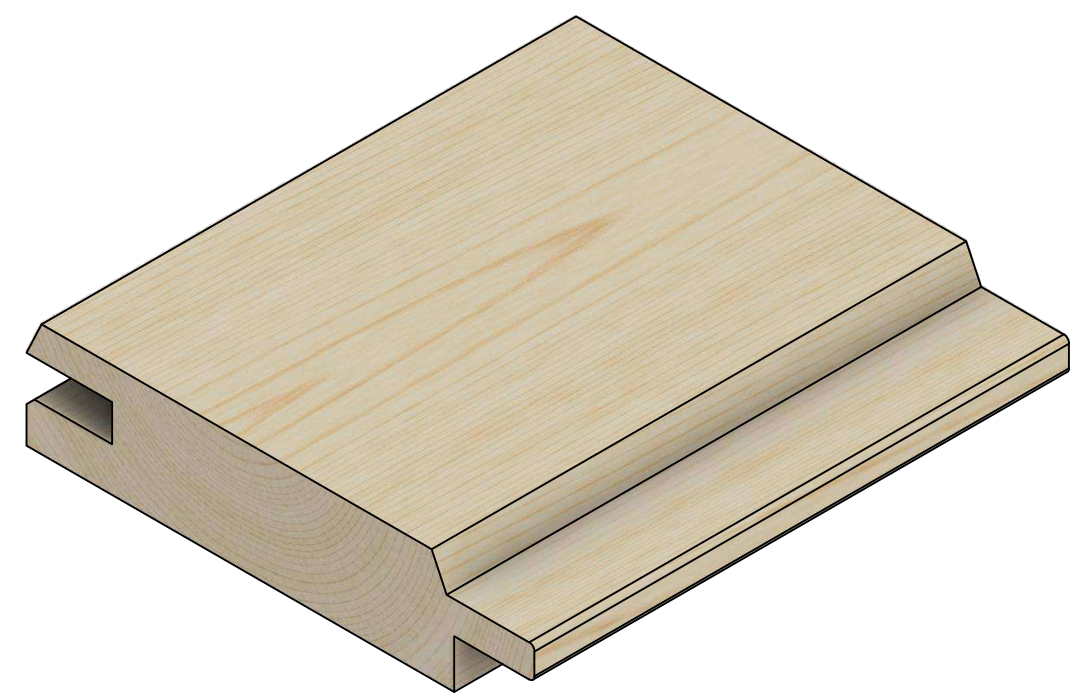
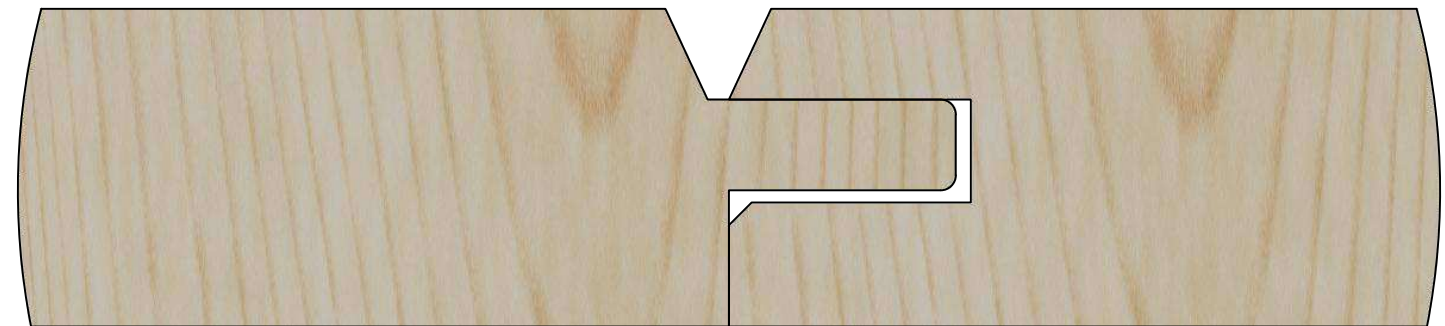
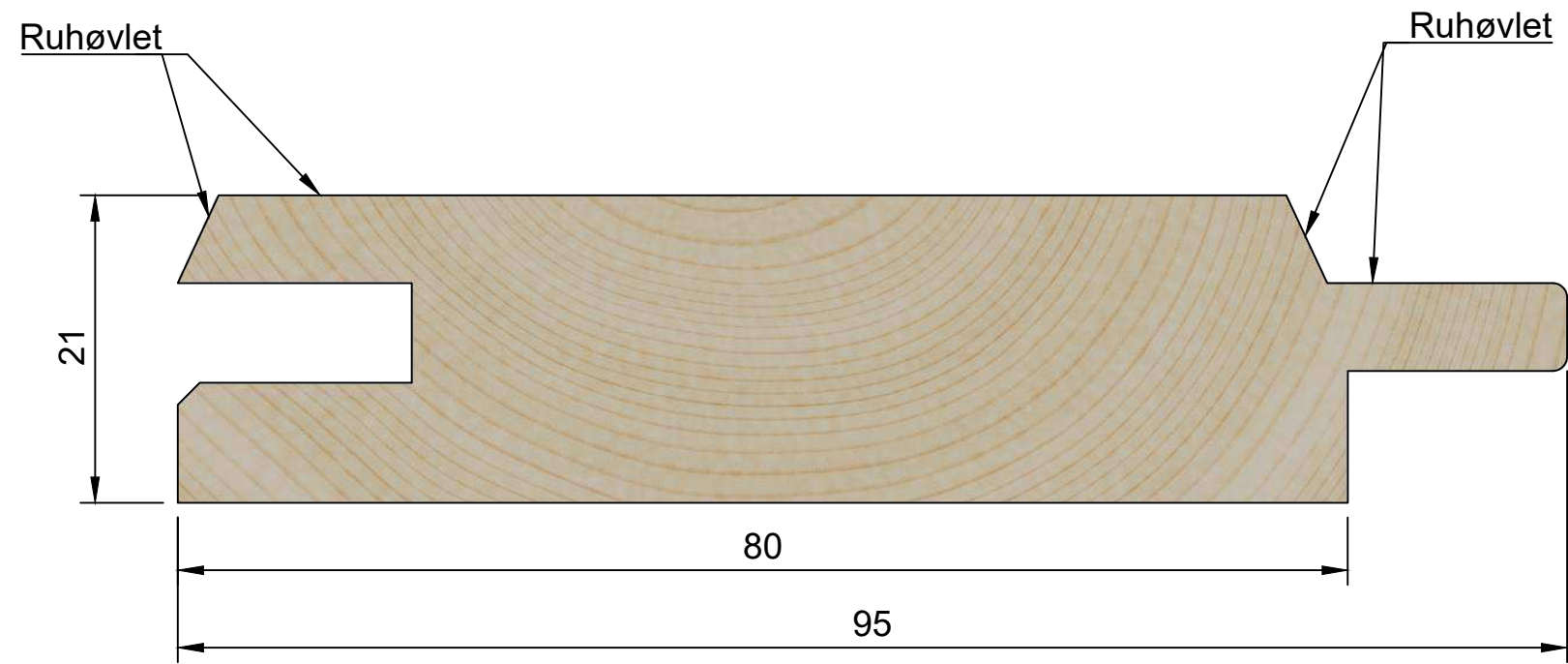

			
<b>Brandkrav:</b> K1 10 D-s2,d0 opsat på substrat A2-s1,d0 min. densitet 10kg/m3 (Se iverigt DoP).		<b>Titel:</b> SW14 AART Medium 21x95mm, Salg	
<b>Tegner:</b>	<b>Dato</b> 17-11-2020	<b>Godkendt af:</b>	<b>Godkendt dato:</b>
<b>Rev.</b>	<b>Rev. dato</b>	<b>Note:</b> Alle mål er i mm. Tegningen er ikke målfast	<b>Sheet</b> 1/1

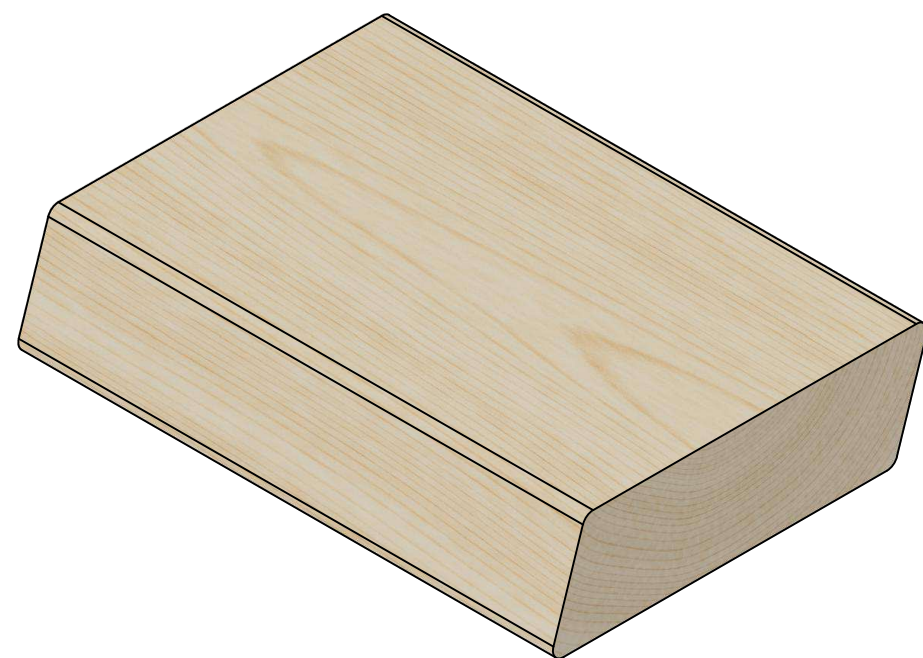
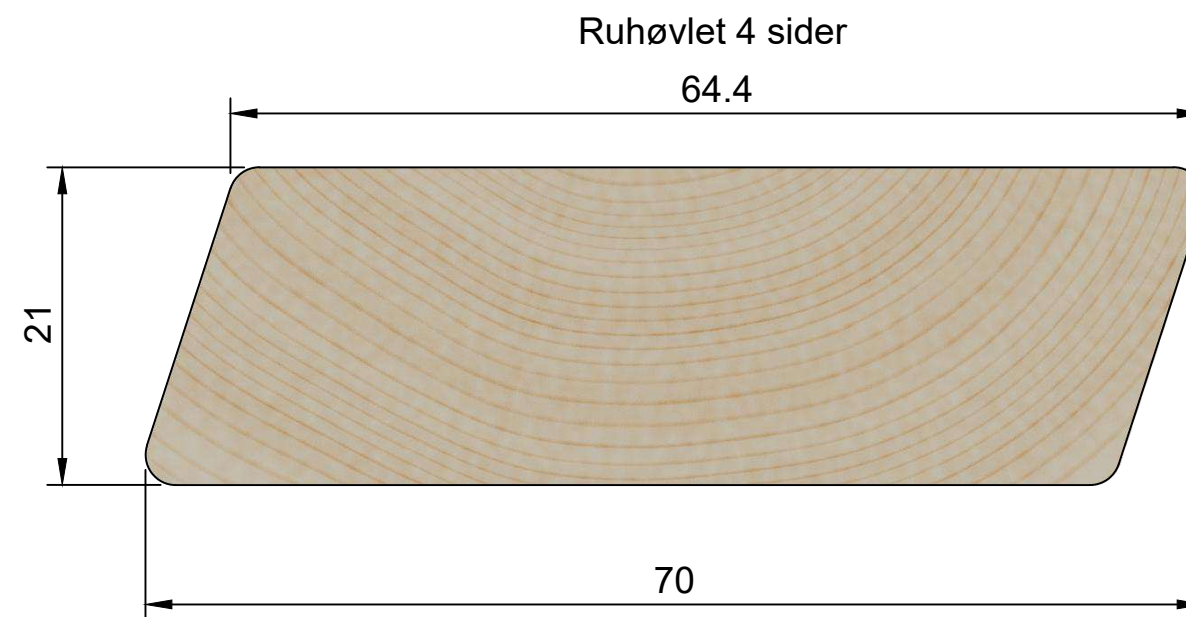

			
<b>Brandkrav:</b> D-s2,d0 (Se iøvrigt DoP).		<b>Titel:</b> SW16 Rombe-profil 21x70mm, Salg	
<b>Tegner:</b>	<b>Dato</b> 09-11-2020	<b>Godkendt af:</b>	<b>Godkendt dato:</b>
<b>Rev.</b> A	<b>Rev. dato</b> 18-07-2022	<b>Note:</b> Alle mål er i mm. Tegningen er ikke målfast	<b>Sheet</b> 1/1

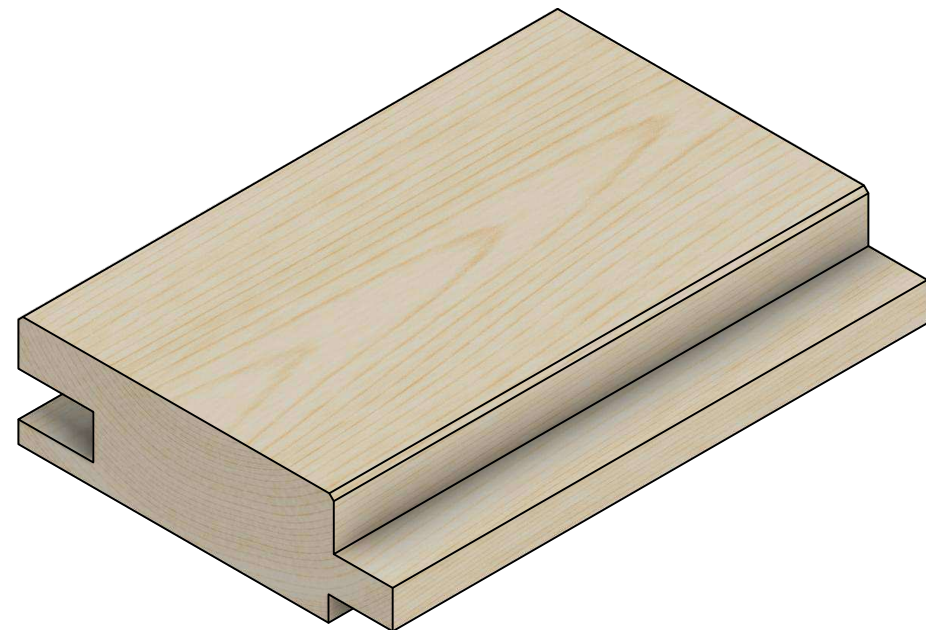
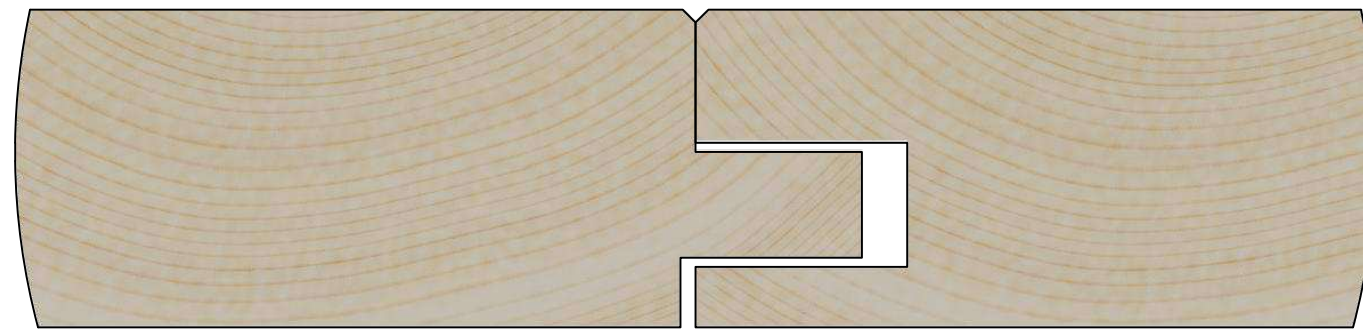
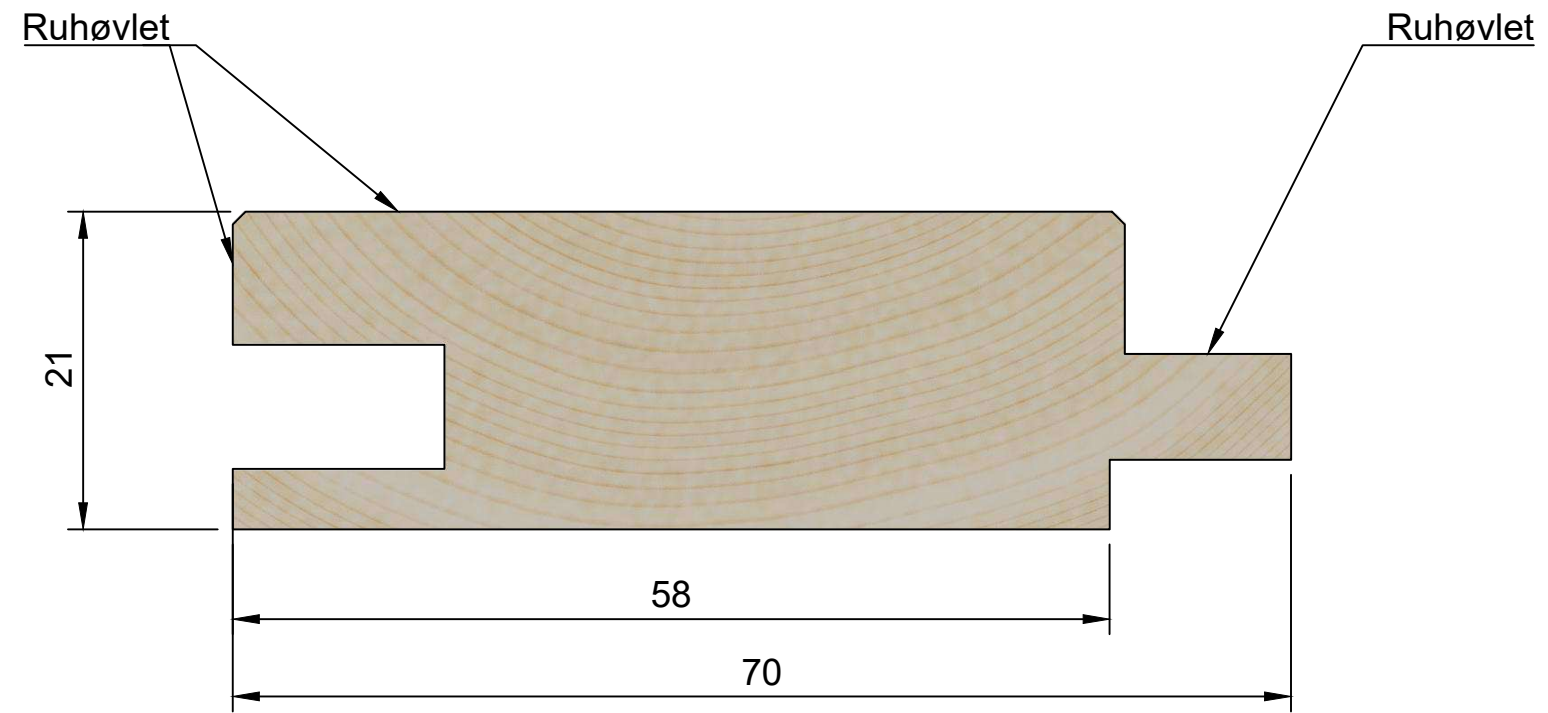

<b>Brandkrav:</b> K1 10 D-s2,d0 opsat på substrat A2-s1,d0 min. densitet 10kg/m3 (Se iverigt DoP).		<b>Titel:</b> SW17 Tett 21x70mm, Salg	
<b>Tegner:</b>	<b>Dato</b> 10-11-2020	<b>Godkendt af:</b>	<b>Godkendt dato:</b>
<b>Rev.</b>	<b>Rev. dato</b>	<b>Note:</b> Alle mål er i mm. Tegningen er ikke målfast	<b>Sheet</b> 1/1

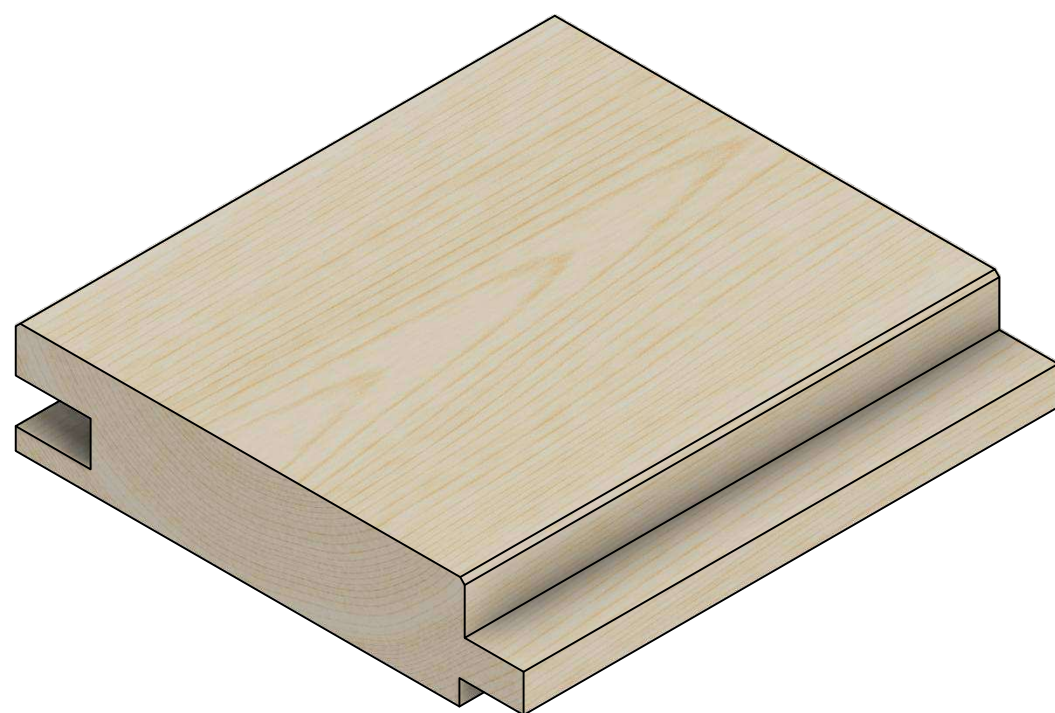
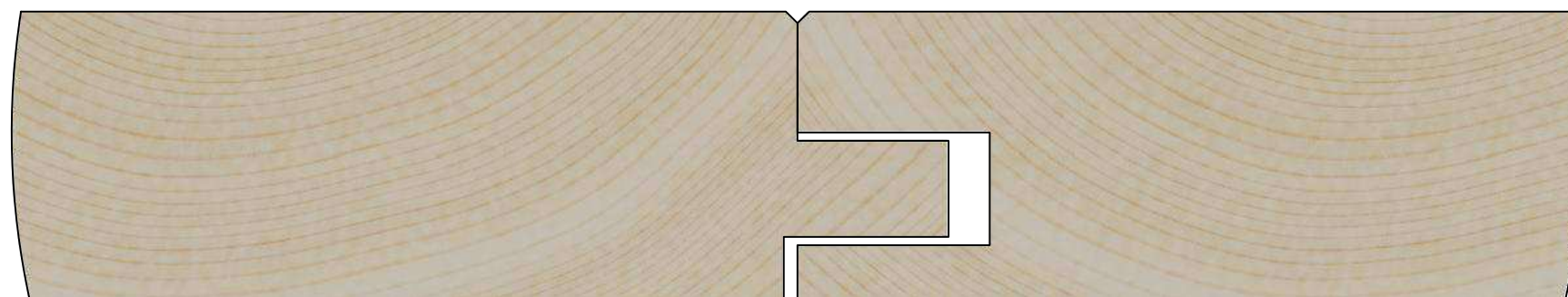
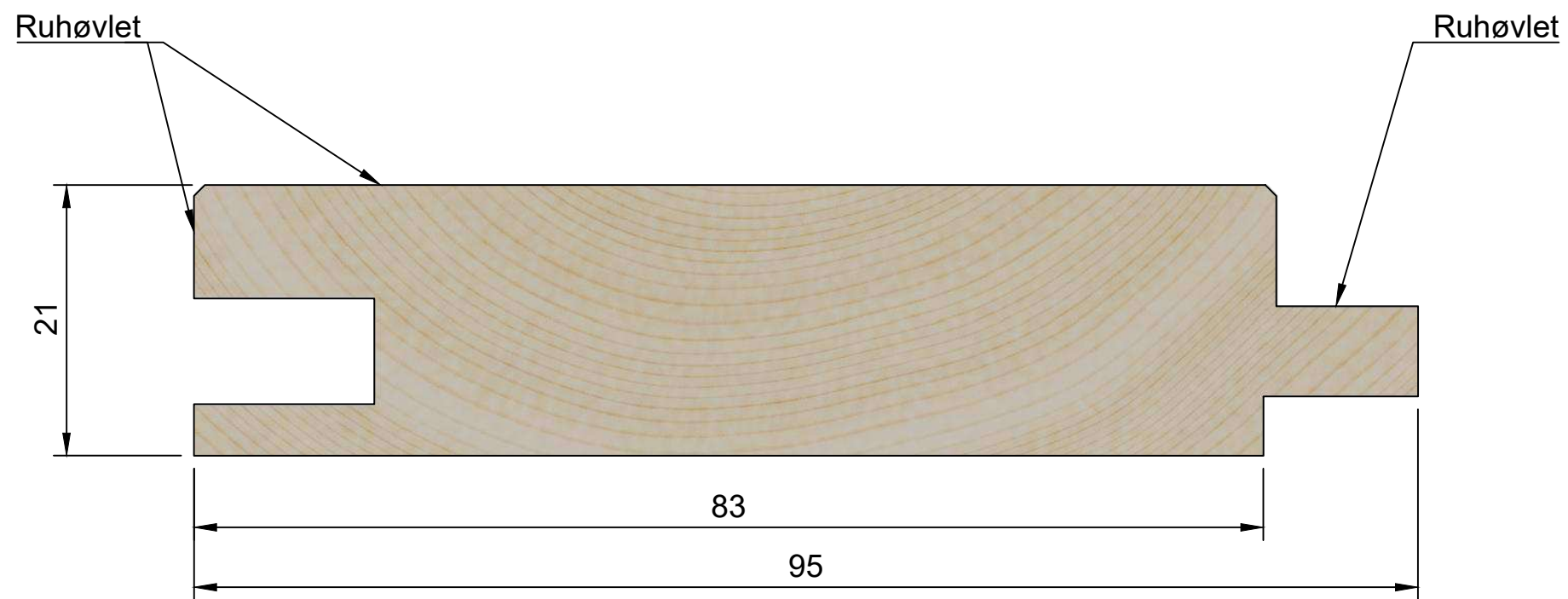

			
<b>Brandkrav:</b> K1 10 D-s2,d0 opsat på substrat A2-s1,d0 min. densitet 10kg/m3 (Se iøvrigt DoP).		<b>Titel:</b> SW17 Tett 21x95mm, Salg	
<b>Tegner:</b>	<b>Dato</b> 10-11-2020	<b>Godkendt af:</b>	<b>Godkendt dato:</b>
<b>Rev.</b>	<b>Rev. dato</b>	<b>Note:</b> Alle mål er i mm. Tegningen er ikke målfast	<b>Sheet</b> 1/1

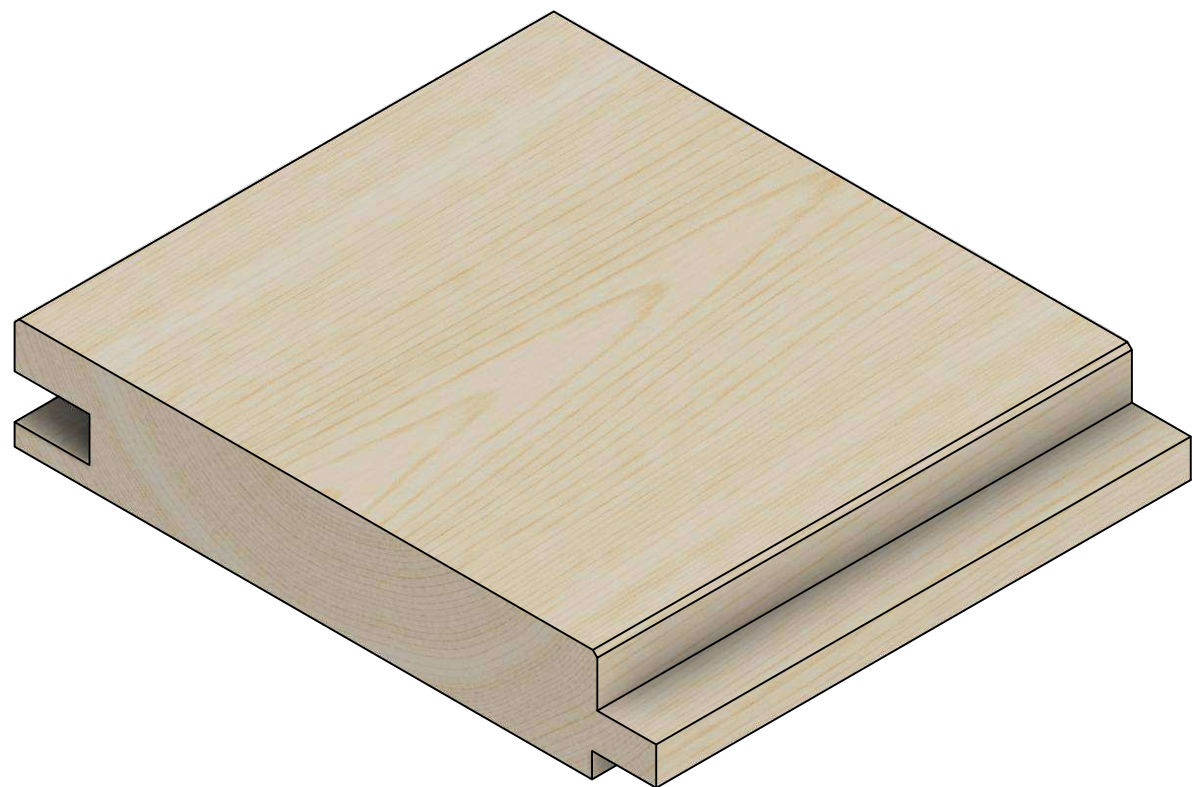
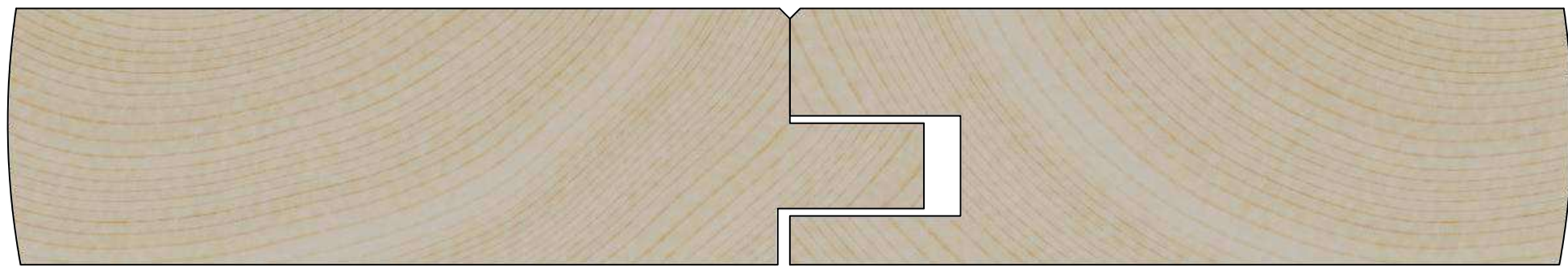
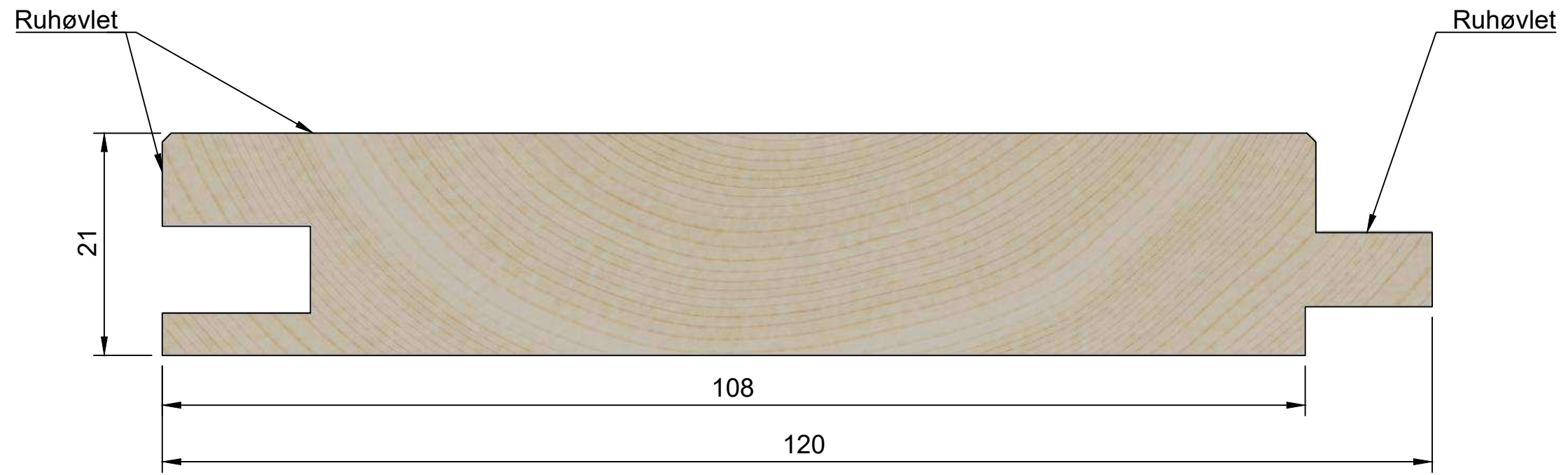

<b>Brandkrav:</b> K1 10 D-s2,d0 opsat på substrat A2-s1,d0 min. densitet 10kg/m3 (Se iverigt DoP).		<b>Titel:</b> SW17 Tett 21x120mm, Salg	
<b>Tegner:</b>	<b>Dato</b> 10-11-2020	<b>Godkendt af:</b>	<b>Godkendt dato:</b>
<b>Rev.</b>	<b>Rev. dato</b>	<b>Note:</b> Alle mål er i mm. Tegningen er ikke målfast	<b>Sheet</b> 1/1

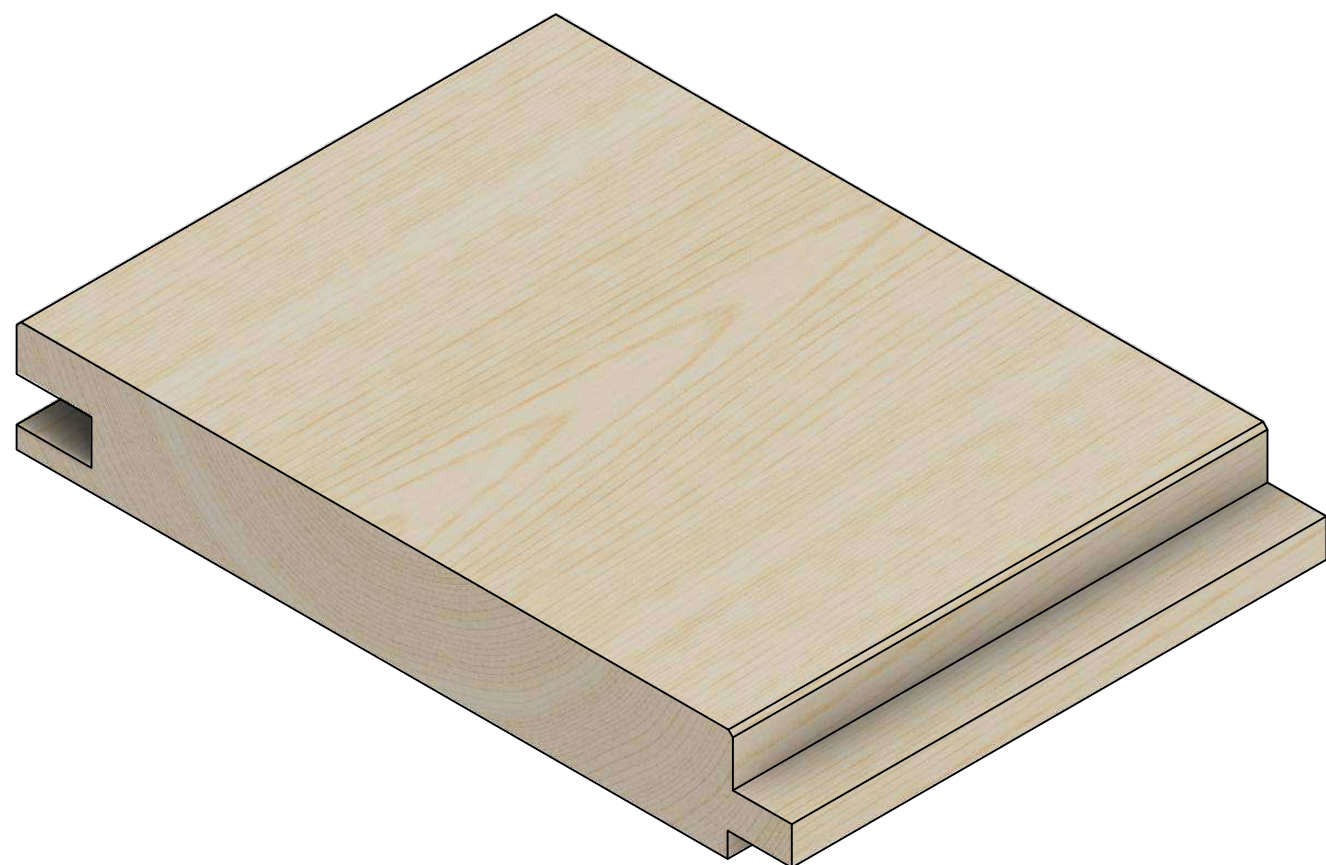
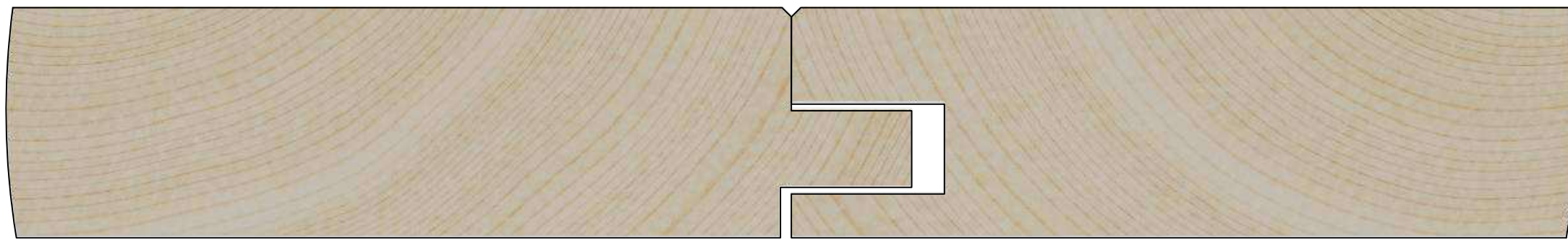
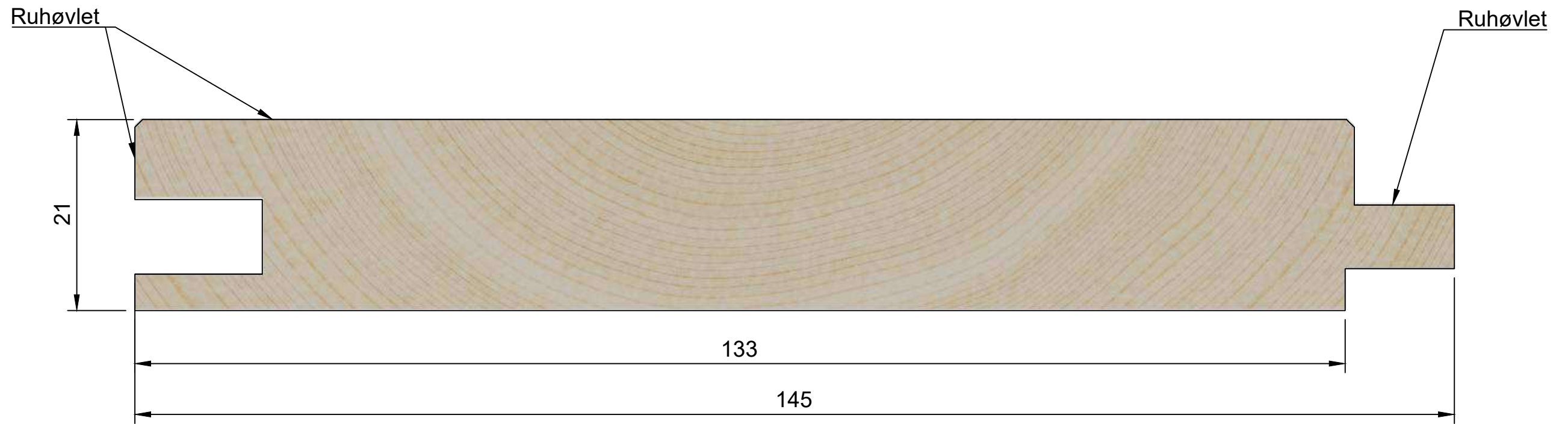

<b>Brandkrav:</b> K1 10 D-s2,d0 opsat på substrat A2-s1,d0 min. densitet 10kg/m3 (Se iverigt DoP).		<b>Titel:</b> SW17 Tett 21x145mm, Salg	
<b>Tegner:</b>	<b>Dato</b> 10-11-2020	<b>Godkendt af:</b>	<b>Godkendt dato:</b>
<b>Rev.</b>	<b>Rev. dato</b>	<b>Note:</b> Alle mål er i mm. Tegningen er ikke målfast	<b>Sheet</b> 1/1

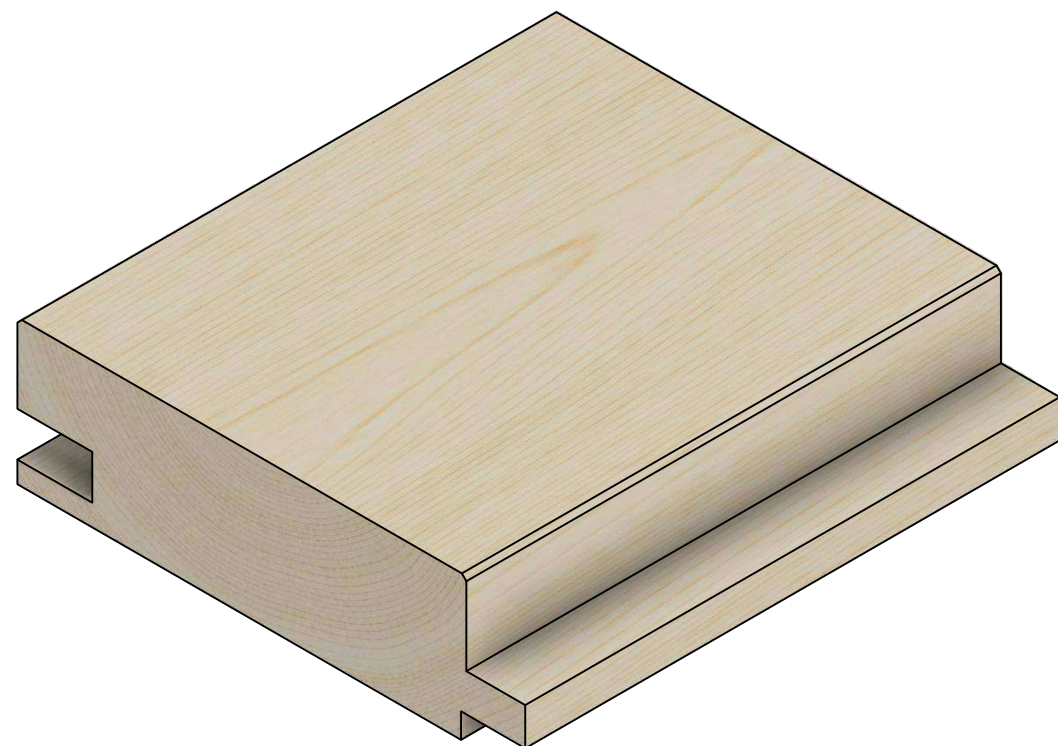
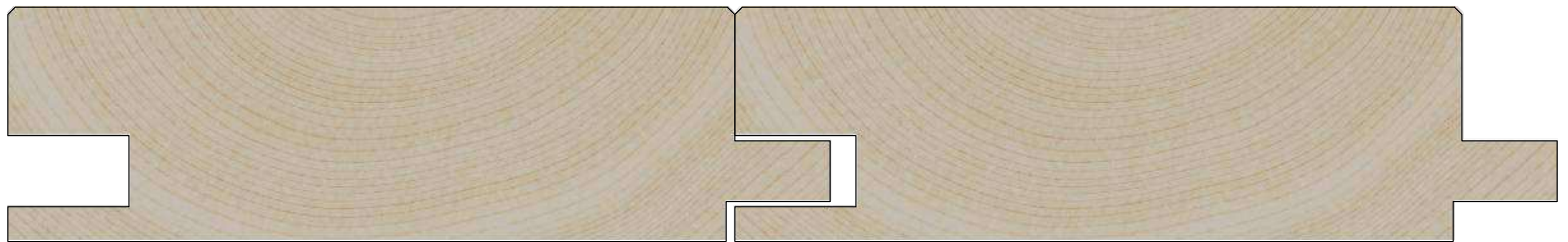
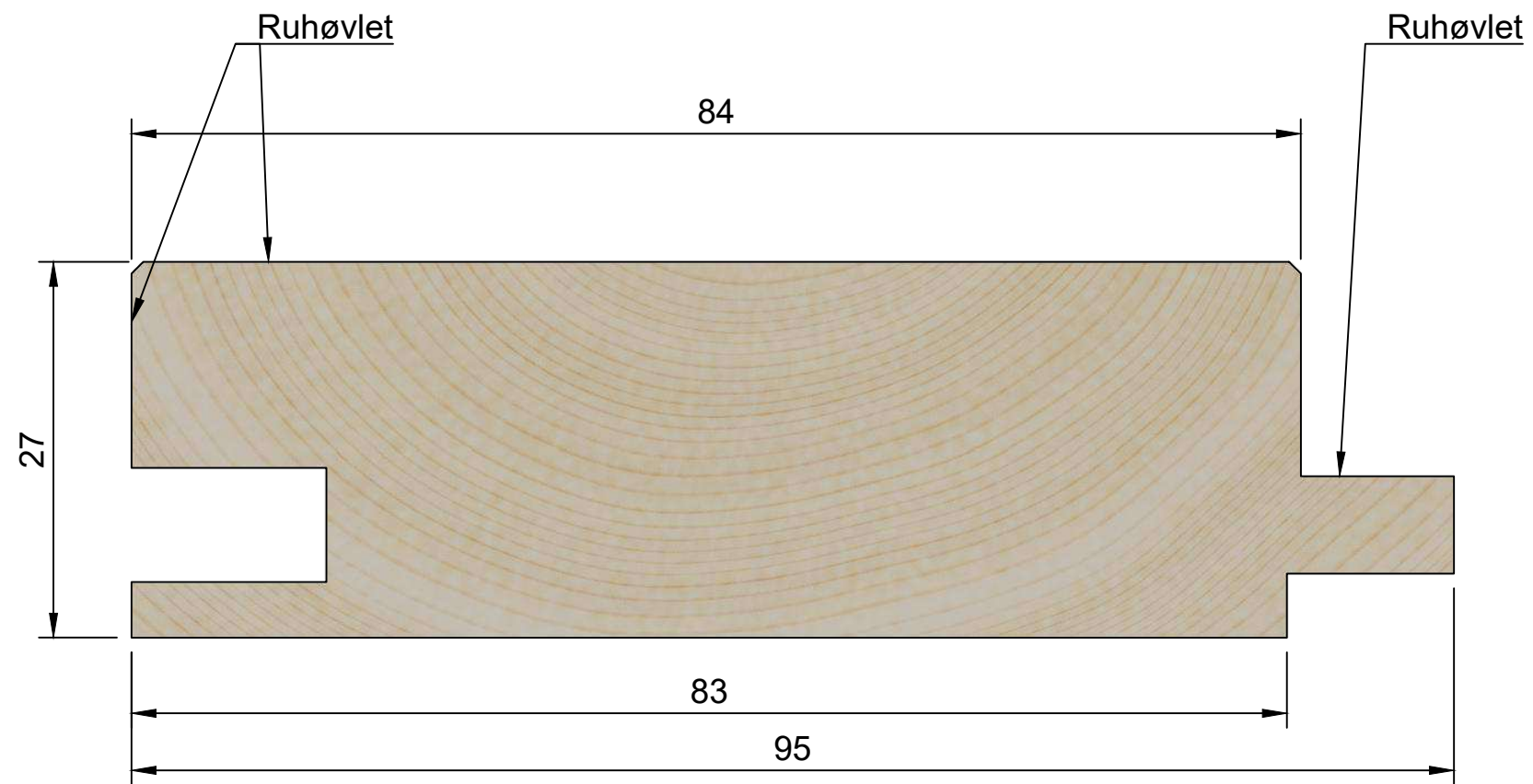

<b>Brandkrav:</b> K1 10 D-s2,d0 opsat på substrat A2-s1,d0 min. densitet 300kg/m <sup>3</sup>		<b>Titel:</b> SW17 Tett 27x95mm, Salg	
<b>Tegner:</b> LA	<b>Dato</b> 23-03-2022	<b>Godkendt af:</b> PK	<b>Godkendt dato:</b>
<b>Rev.</b>	<b>Rev. dato</b>	<b>Note:</b> Alle mål er i mm. Tegningen er ikke målfast	<b>Sheet</b> 1/1



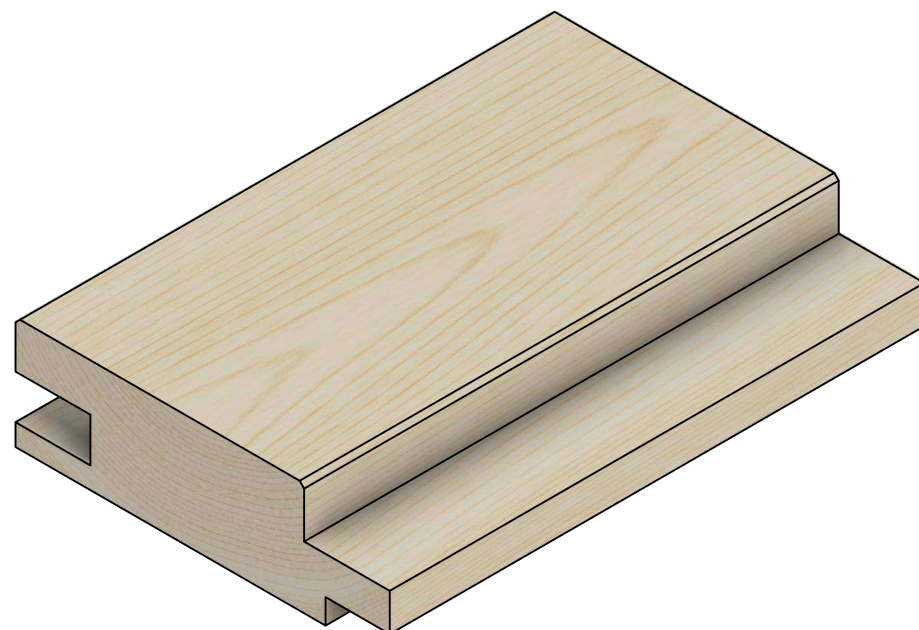
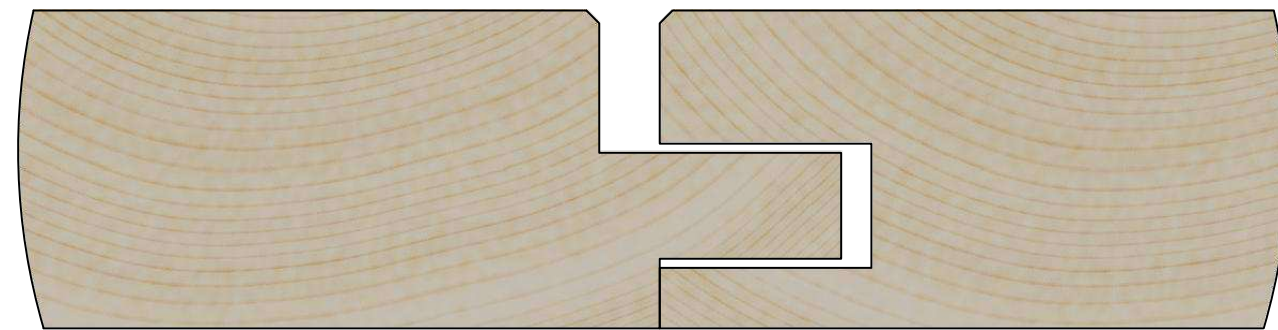
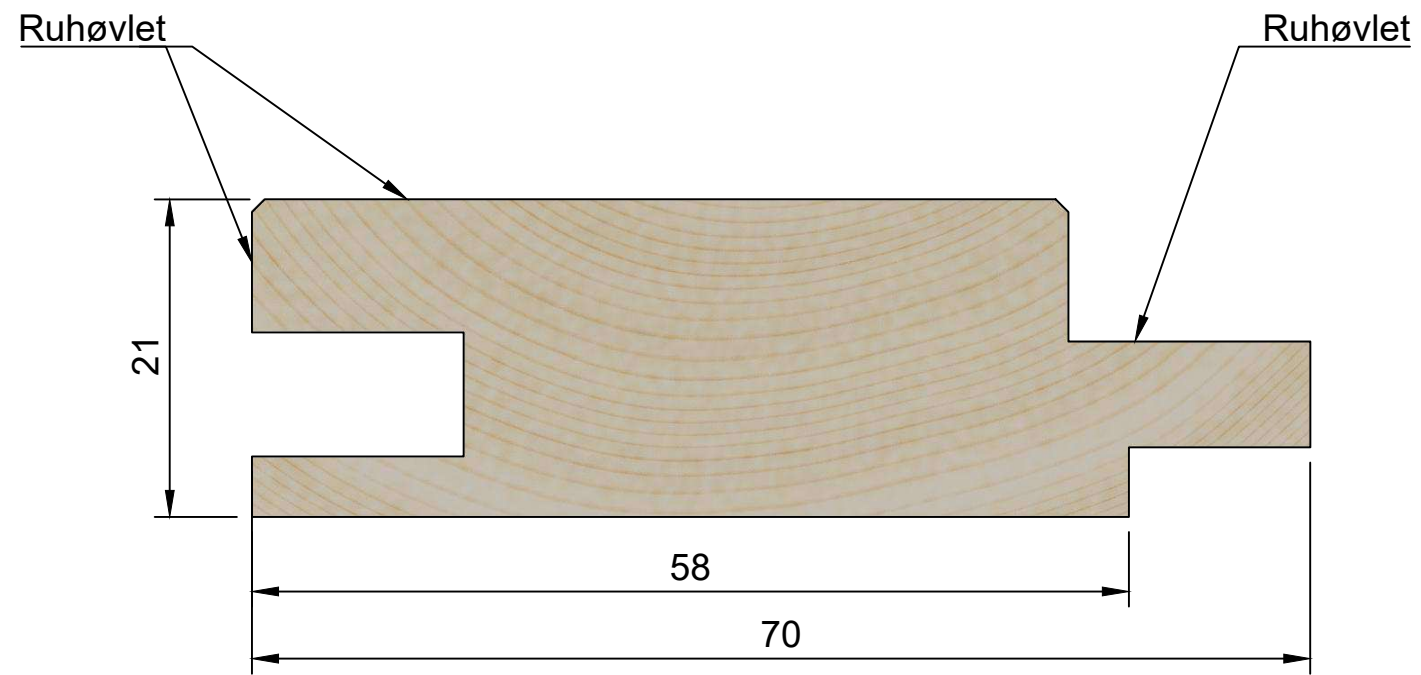

<b>Brandkrav:</b> K1 10 D-s2,d0 opsat på substrat A2-s1,d0 min. densitet 10kg/m3 (Se iøvrigt DoP).		<b>Titel:</b> SW18 Skygge 21x70mm, Salg	
<b>Tegner:</b>	<b>Dato:</b> 10-11-2020	<b>Godkendt af:</b>	<b>Godkendt dato:</b>
<b>Rev.:</b>	<b>Rev. dato:</b>	<b>Note:</b> Alle mål er i mm. Tegningen er ikke målfast	<b>Sheet:</b> 1/1

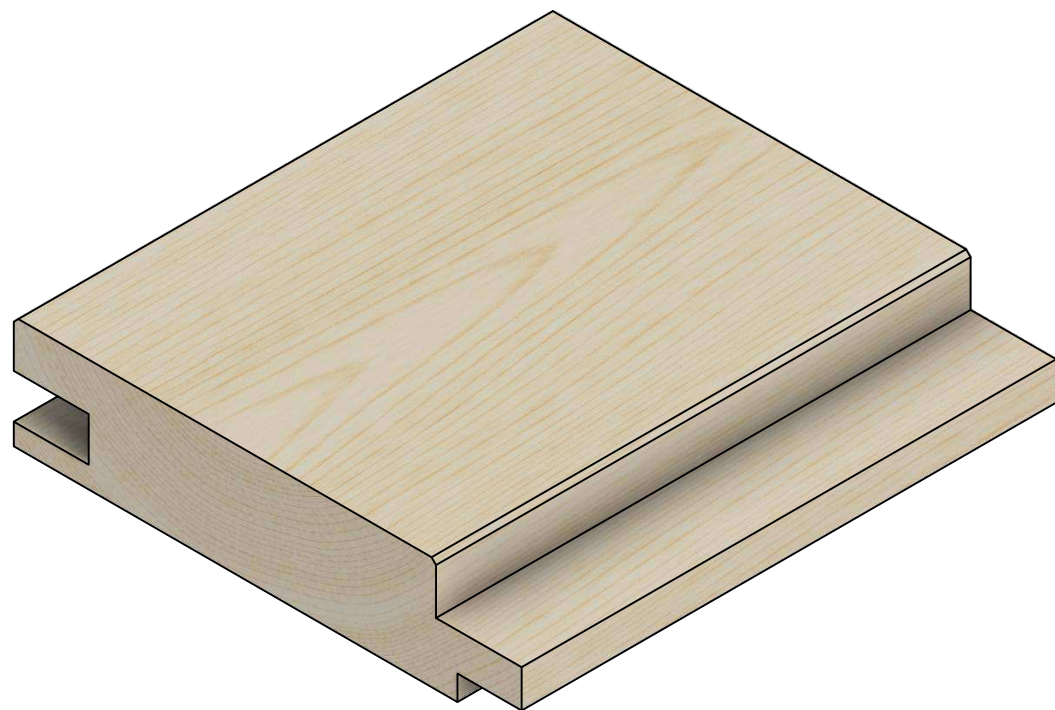
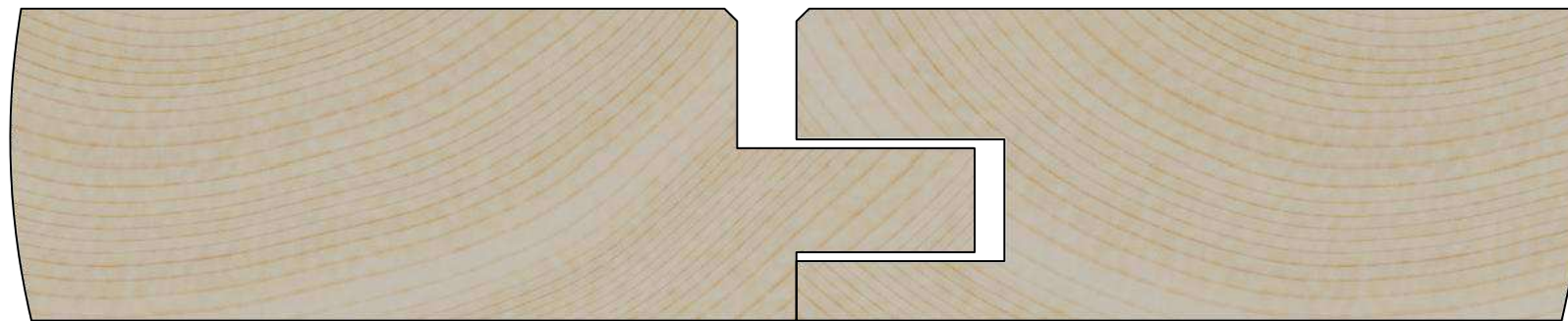
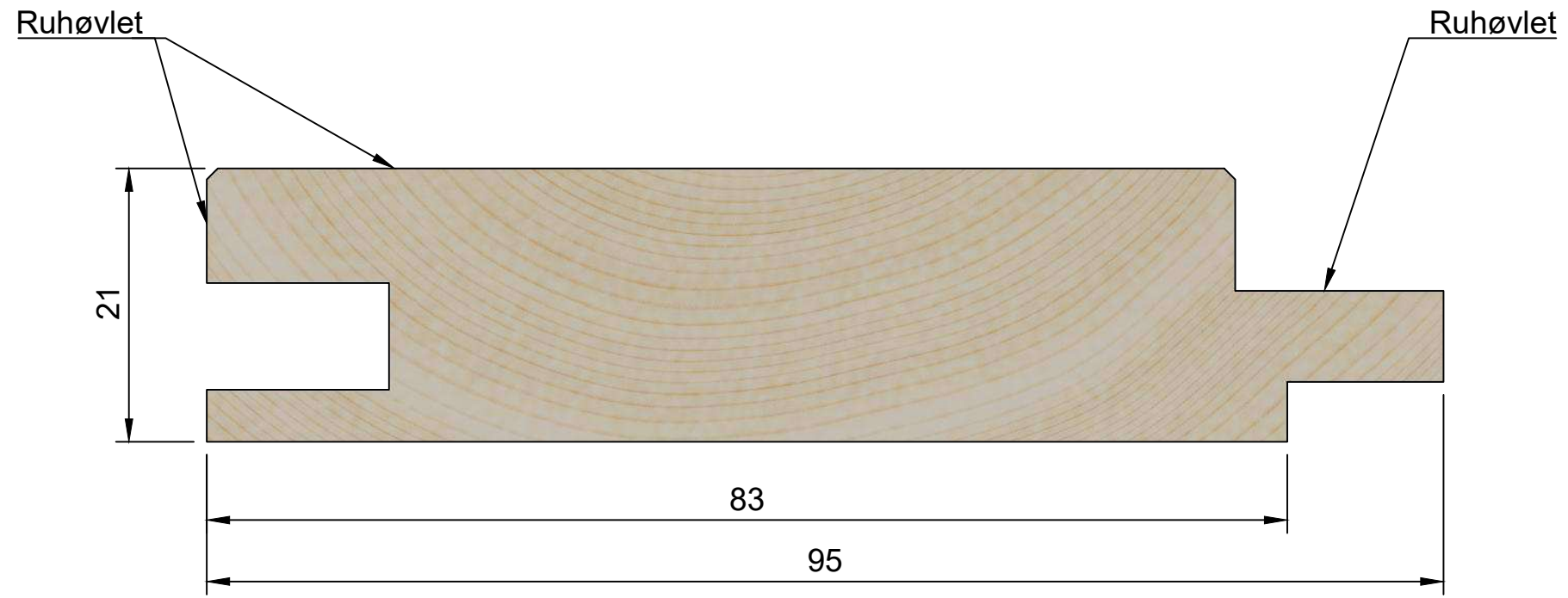

<b>Brandkrav:</b> K1 10 D-s2,d0 opsat på substrat A2-s1,d0 min. densitet 10kg/m3 (Se iverigt DoP).		<b>Titel:</b> SW18 Skygge 21x95mm, Salg	
<b>Tegner:</b>	<b>Dato</b> 10-11-2020	<b>Godkendt af:</b>	<b>Godkendt dato:</b>
<b>Rev.</b>	<b>Rev. dato</b>	<b>Note:</b> Alle mål er i mm. Tegningen er ikke målfast	<b>Sheet</b> 1/1

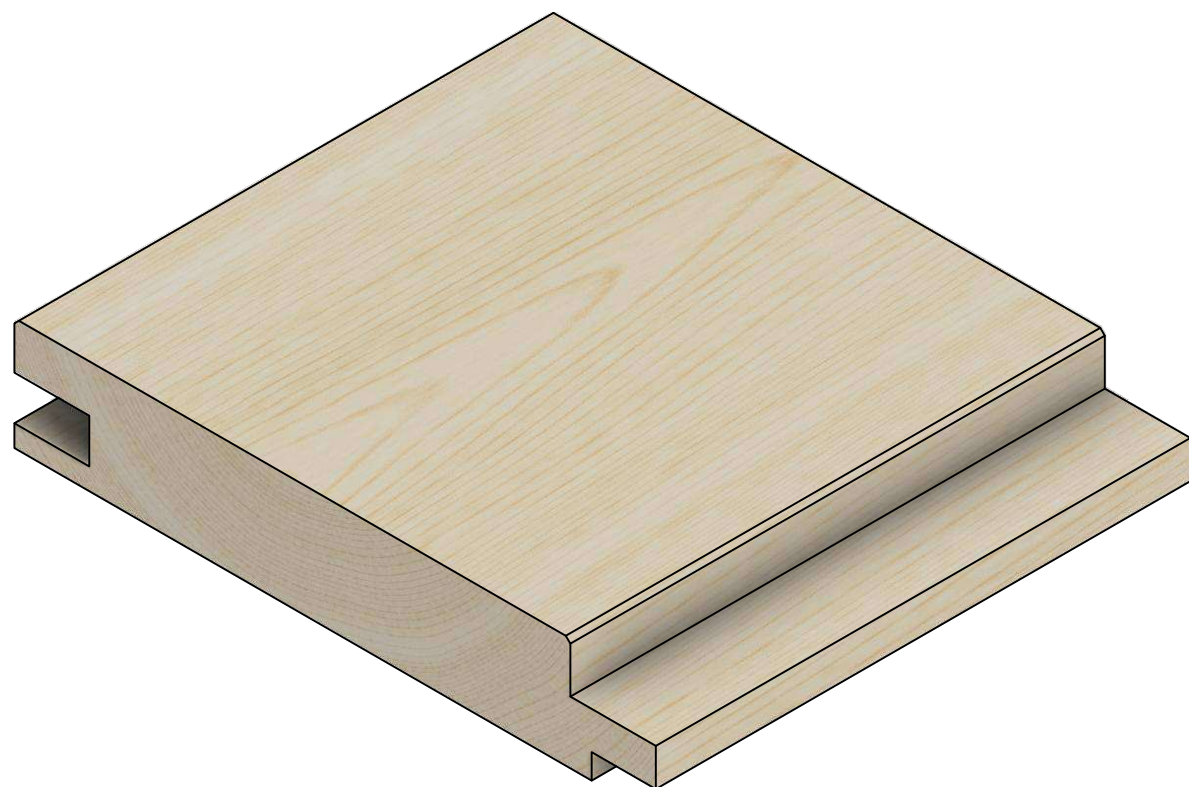
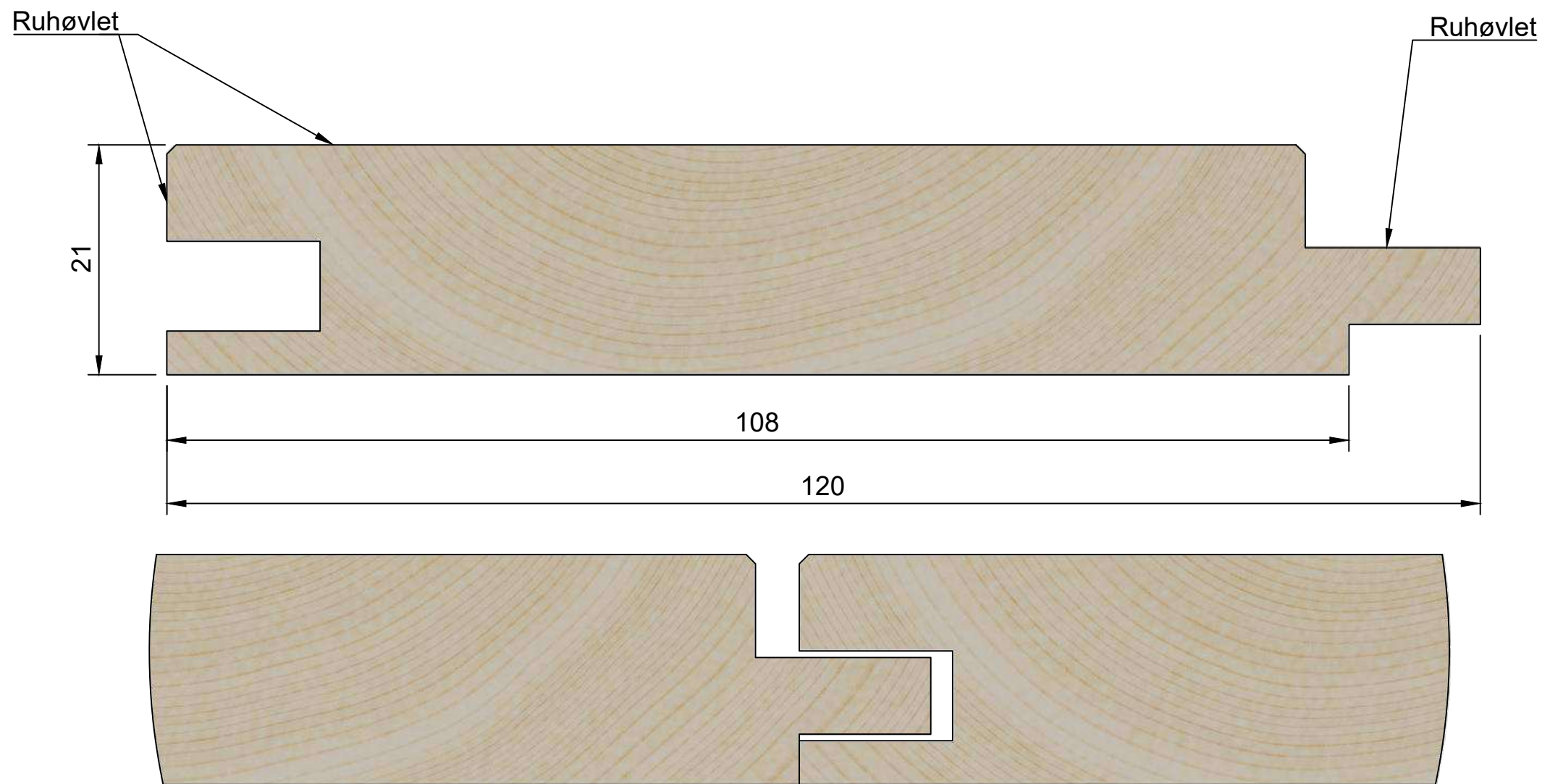

<b>Brandkrav:</b> K1 10 D-s2,d0 opsat på substrat A2-s1,d0 min. densitet 10kg/m3 (Se iøvrigt DoP).		<b>Titel:</b> SW18 Skygge 21x120mm, Salg	
<b>Tegner:</b>	<b>Dato</b> 10-11-2020	<b>Godkendt af:</b>	<b>Godkendt dato:</b>
<b>Rev.</b>	<b>Rev. dato</b>	<b>Note:</b> Alle mål er i mm. Tegningen er ikke målfast	<b>Sheet</b> 1/1

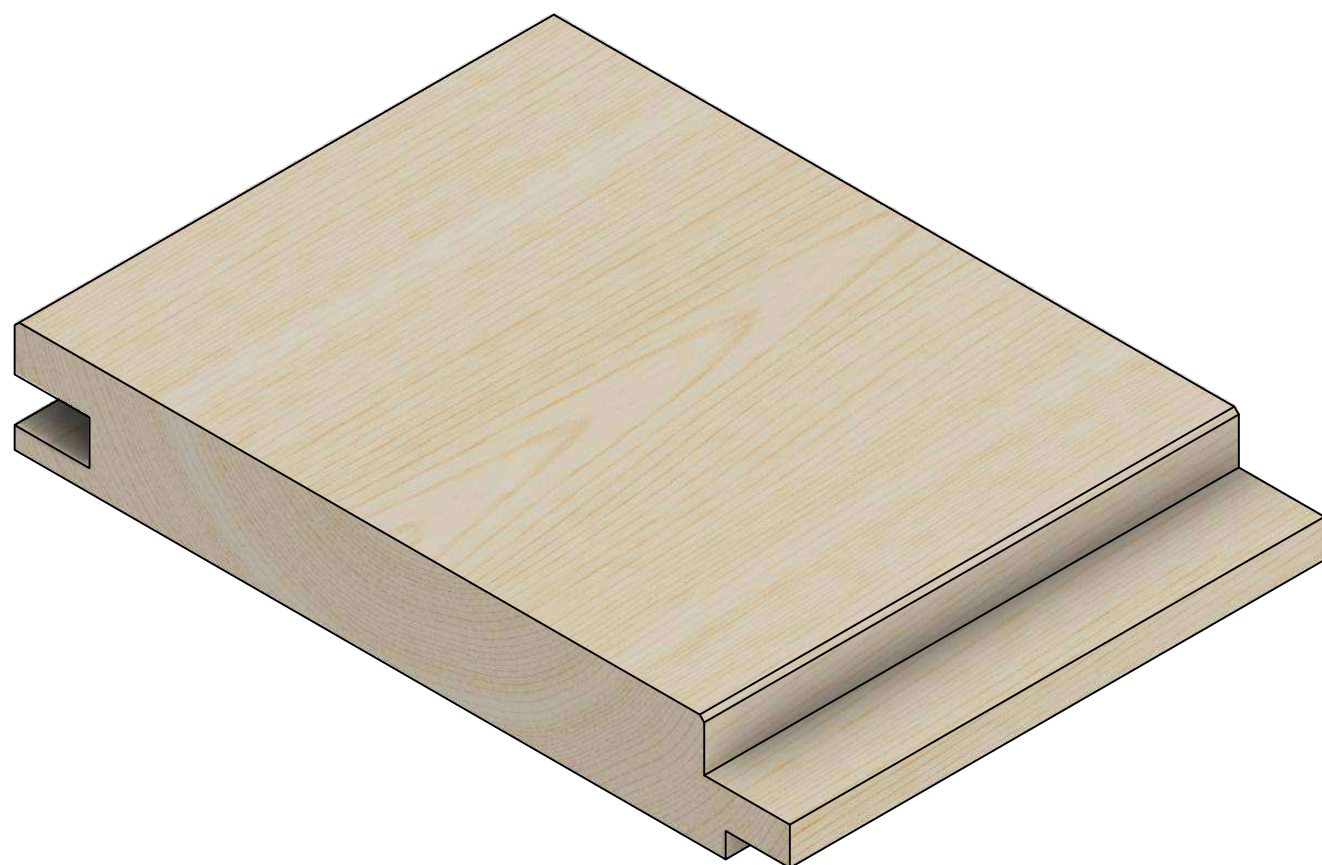
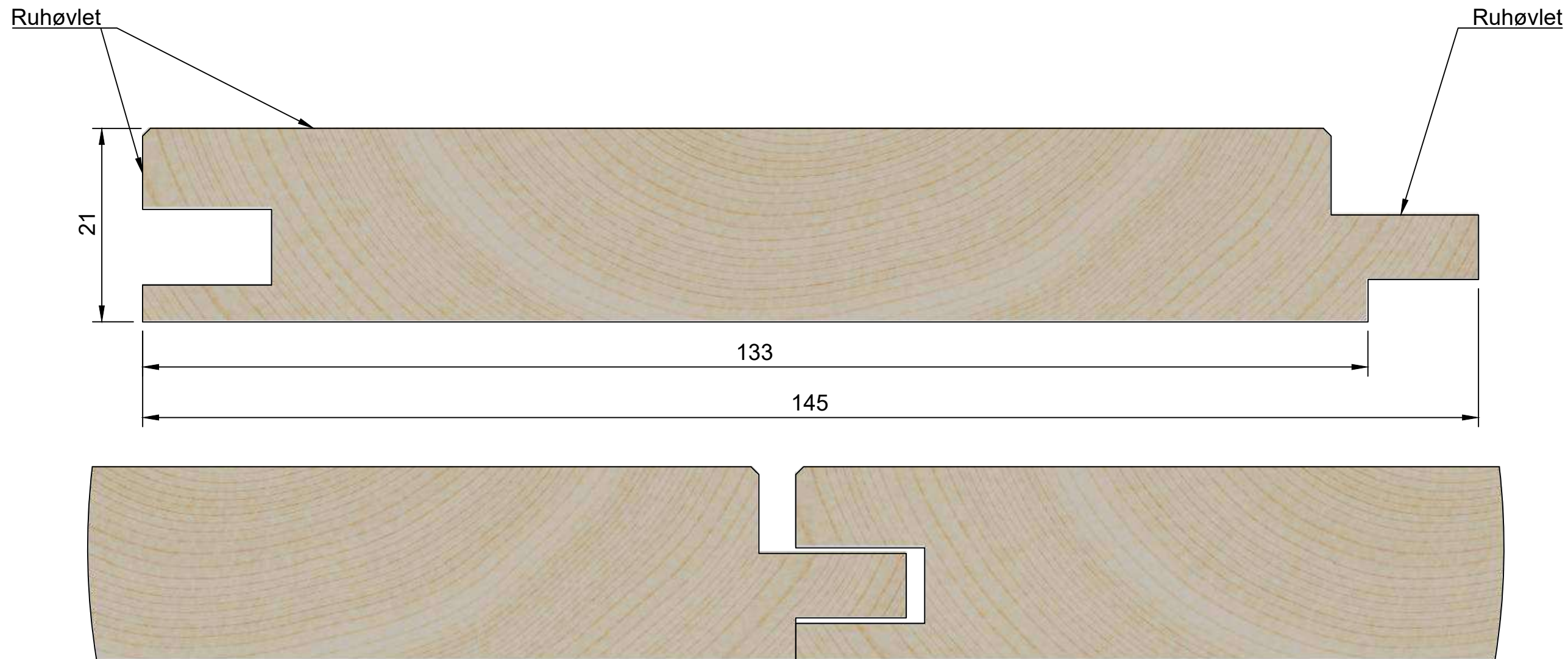

			
<b>Brandkrav:</b> K1 10 D-s2,d0 opsat på substrat A2-s1,d0 min. densitet 10kg/m3 (Se iverigt DoP).		<b>Titel:</b> SW18 Skygge 21x145mm, Salg	
<b>Tegner:</b>	<b>Dato</b> 10-11-2020	<b>Godkendt af:</b>	<b>Godkendt dato:</b>
<b>Rev.</b>	<b>Rev. dato</b>	<b>Note:</b> Alle mål er i mm. Tegningen er ikke målfast	<b>Sheet</b> 1/1

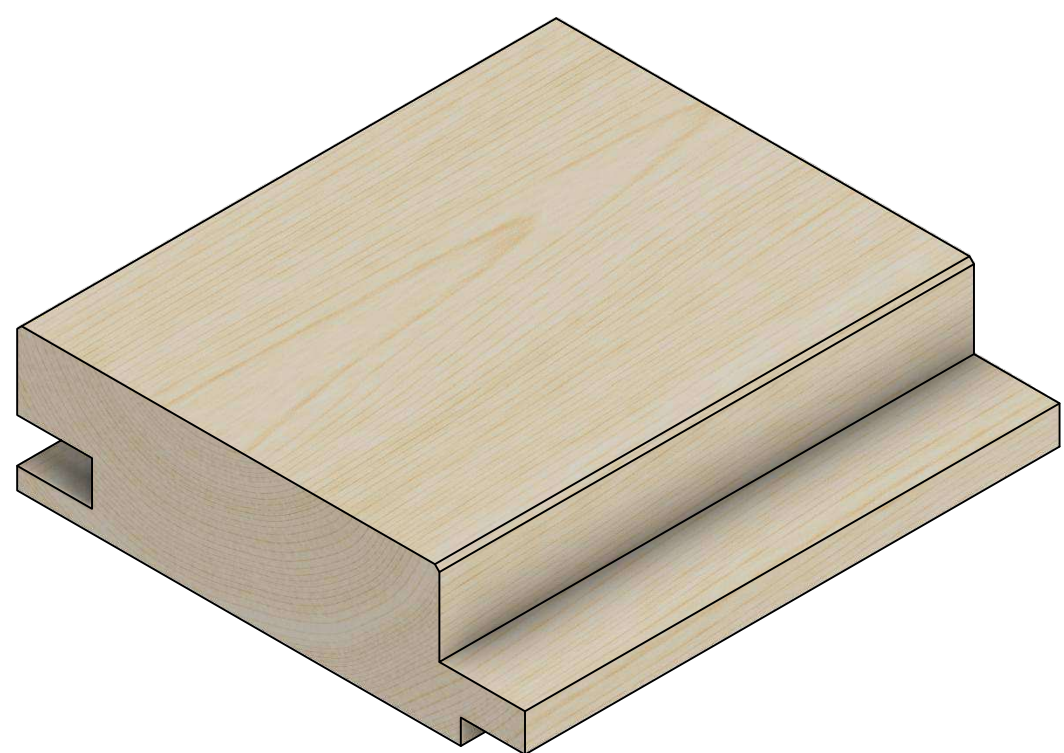
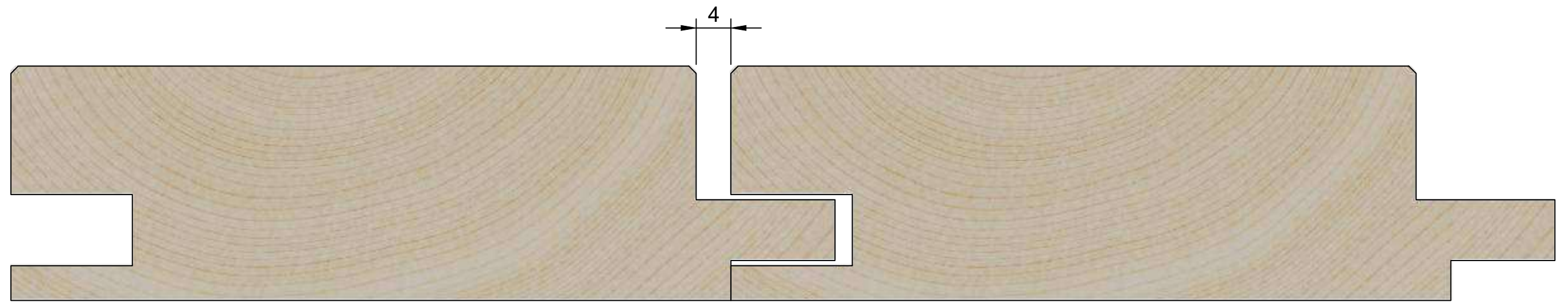
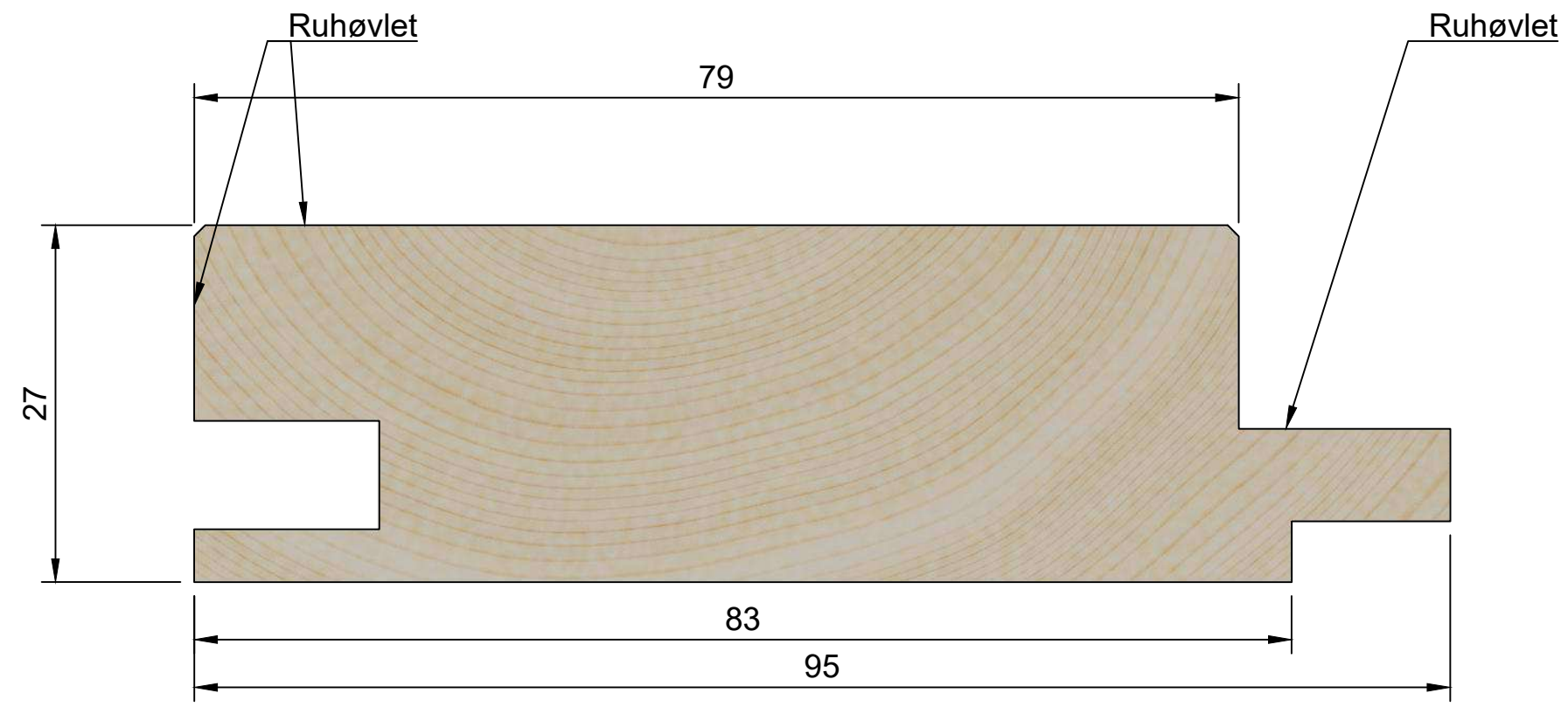

<b>Brandkrav:</b> K1 10 D-s2,d0 opsat på substrat A2-s1,d0 min. densitet 300 kg/m3		<b>Titel:</b> SW18 Skygge 27x95mm, Salg	
<b>Tegner:</b> LA	<b>Dato</b> 24-11-2021	<b>Godkendt af:</b> PK	<b>Godkendt dato:</b> 24-11-2021
<b>Rev.</b>	<b>Rev. dato</b>	<b>Note:</b> Alle mål er i mm. Tegningen er ikke målfast	<b>Sheet</b> 1/1

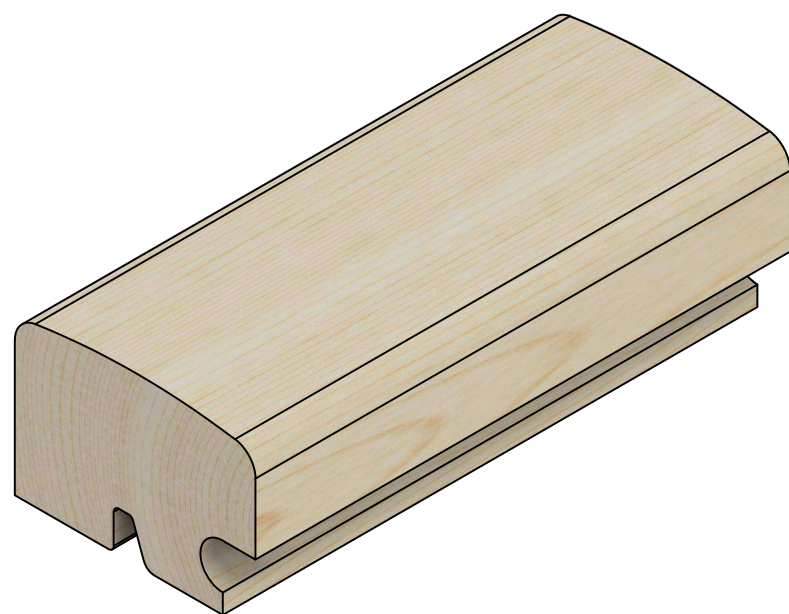
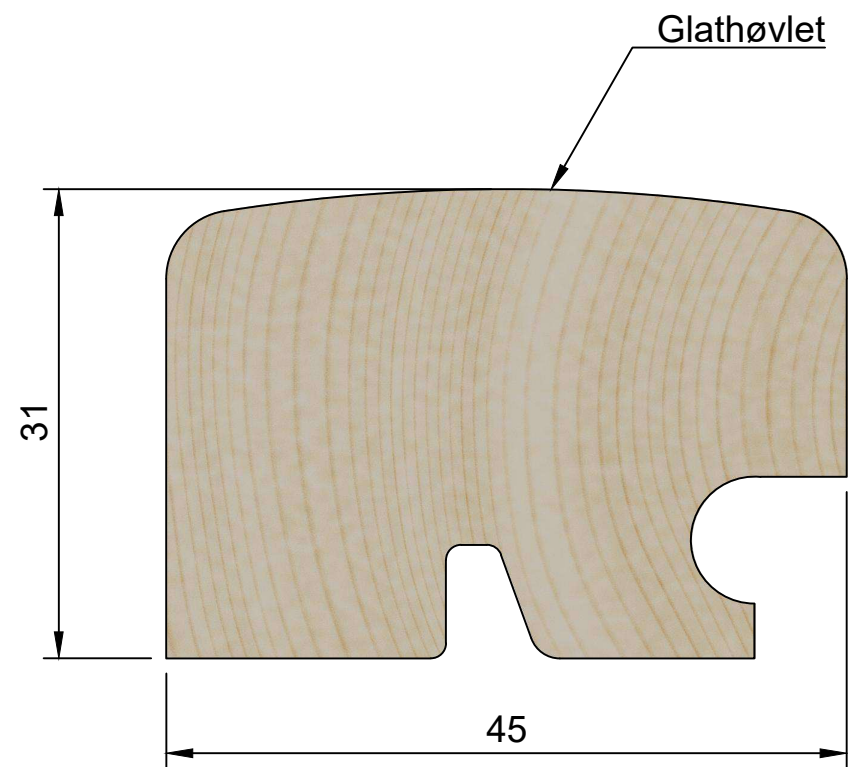

 <b>Superwood<sup>®</sup></b>			
<b>Brandkrav:</b> Anvendelse: Facadeliste = D-s2, d0 (se i øvrigt DoP) Anvendelse: Terrasseliste= Hører ikke ind under harmoniseret EU standard. Derfor ikke krav om CE-mærkning.		Titel: <b>SW19 Multiliste 31x45mm, Salg</b>	
Tegner:	Dato 11-11-2020	Godkendt af:	Godkendt dato:
Rev.	Rev. dato	Note: Alle mål er i mm. Tegningen er ikke målfast	Sheet 1/1